



Congratulations,

By purchasing the  you have made an excellent choice.

The purchase of a professional espresso coffee-maker involves various elements of selection: the name of the manufacturing firm, the machine's specific functions, its technical reliability, the option of immediate and suitable servicing, its price. You certainly evaluated all these factors and then made your choice: the .

We think you have made the best choice and after every coffee and cappuccino you will be able to assess this.

You will see how practical, convenient and efficient working with .

If this is the first time you have bought a **Victoria Arduino** coffee machine, welcome to high quality coffee-making; if you are already a customer of ours, we feel flattered by the trust you have shown us.

Thanks of the preference.

With best wishes,

**Victoria Arduino**



## TECHNICAL CHARACTERISTICS

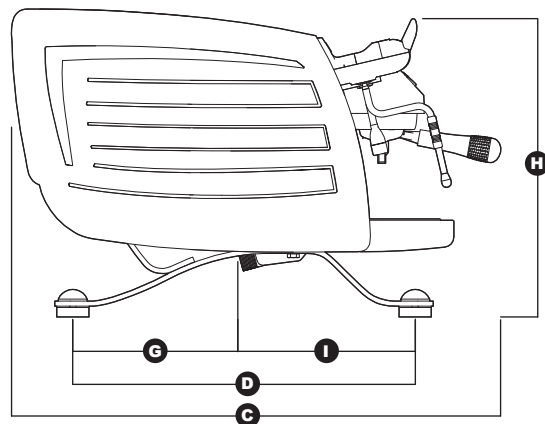
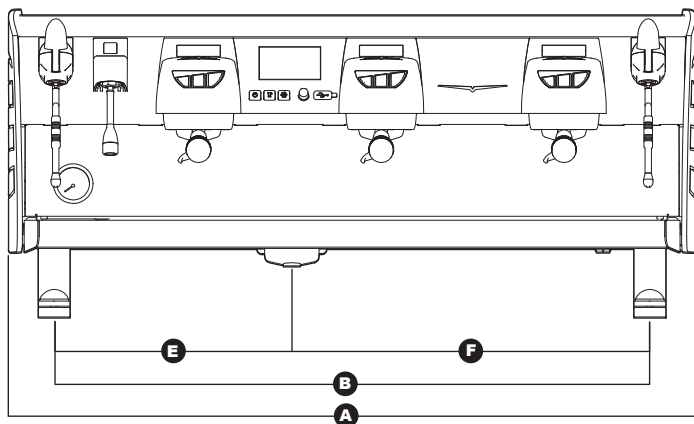

	2 Groups		3 Groups	
<b>NET WEIGHT</b>	85 kg	187 lb	110 kg	243 lb
<b>GROSS WEIGHT</b>	105 kg	231 lb	130 kg	287 lb
<b>POWER</b>	7300 W	7300 W	9100 W	9100 W
<b>DIMENSIONS</b>	<b>A</b> 822 mm	<b>A</b> 32,36 in	<b>A</b> 1072 mm	<b>A</b> 42,2 in
	<b>B</b> 729 mm	<b>B</b> 28,7 in	<b>B</b> 979 mm	<b>B</b> 38,54 in
	<b>C</b> 690 mm	<b>C</b> 27,17 in	<b>C</b> 690 mm	<b>C</b> 27,17 in
	<b>D</b> 584 mm	<b>D</b> 22,99 in	<b>D</b> 584 mm	<b>D</b> 22,99 in
	<b>E</b> 390 mm	<b>E</b> 15,35 in	<b>E</b> 395 mm	<b>E</b> 15,55 in
	<b>F</b> 338 mm	<b>F</b> 13,3 in	<b>F</b> 575 mm	<b>F</b> 22,64 in
	<b>G</b> 369 mm	<b>G</b> 14,53 in	<b>G</b> 369 mm	<b>G</b> 14,53 in
	<b>H</b> 480,5 mm	<b>H</b> 18,92 in	<b>H</b> 480,5 mm	<b>H</b> 18,92 in
	<b>I</b> 215 mm	<b>I</b> 8,46 in	<b>I</b> 215 mm	<b>I</b> 8,46 in

## INDEX

	<b>TECHNICAL CHARACTERISTICS</b> .....	40
<b>1.</b>	<b>MACHINE DESCRIPTION</b> .....	43
1.1	CONTROL PANEL DESCRIPTION .....	44
1.2	ACCESSORIES LIST .....	45
<b>2.</b>	<b>SAFETY PRESCRIPTION</b> .....	46
<b>3.</b>	<b>TRANSPORT AND HANDLING</b> .....	49
3.1	MACHINE IDENTIFICATION .....	49
3.2	TRANSPORT .....	49
3.3	HANDLING .....	49
<b>4.</b>	<b>INSTALLATION AND PRELIMINARY OPERATIONS</b> .....	49
4.1	CABLE STRIP COVERING (OPTIONAL) .....	50
4.2	WATER SPECIFICATIONS .....	50
4.3	ELECTRICITY SPECIFICATIONS .....	50
<b>5.</b>	<b>ADJUSTMENTS TO BE MADE BY A QUALIFIED TECHNICIAN ONLY</b> .....	51
5.1	HOT WATER ECONOMISER ADJUSTMENT .....	51
5.2	REPLACING THE CLOCK BATTERY .....	51
<b>6.</b>	<b>USE</b> .....	52
6.1	COMMISSIONING PROCEDURE OR AFTER BOILER MAINTENANCE .....	52
6.2	SWITCHING THE MACHINE ON/OFF .....	52
6.3	MAKING COFFEE .....	53
6.4	USING STEAM (MANUAL STEAM WAND) .....	54
6.5	MAKING CAPPUCCINO .....	54
6.6	HOT WATER SELECTION .....	54
<b>7.</b>	<b>PROGRAMMING</b> .....	55
7.1	KEY .....	55
7.2	PROGRAMMING .....	55
7.2.1	LANGUAGE .....	56
7.2.2	DOSE PROGRAMMING .....	56
7.2.3	SET POINT TEMPERATURE .....	59
7.2.4	KEY AND DISPLAY SETTINGS .....	61
7.2.5	ENERGY SAVING .....	63
7.2.6	DELIVERY COUNT .....	66

7.2.7	ALARMS .....	66
7.2.8	TECHNICAL SETTINGS .....	67
<b>8.</b>	<b>CLEANING</b> .....	70
8.1	STOP .....	70
8.2	CLEANING THE OUTSIDE OF THE MACHINE .....	70
8.3	CHANGING THE WATER IN THE BOILER .....	70
8.4	CLEANING THE STAINLESS COFFEE-HOLDERS .....	70
8.5	CLEANING THE UNIT WITH THE AID OF THE BLIND FILTER .....	70
8.6	CLEANING FILTERS AND FILTER-HOLDERS .....	70
<b>9.</b>	<b>MAINTENANCE</b> .....	71
9.1	RESIN AND SOFTENER REGENERATION .....	71

ELECTRIC SYSTEM VA388 .....	107
ELECTRIC SYSTEM VA388 (CSA VERSION) .....	108
ELECTRIC SYSTEM VA388 (T3) .....	109
BOILER DIAGRAM VA388 (3 Gr.) .....	110
BOILER DIAGRAM VA388 (2 Gr.) .....	111
BOILER DIAGRAM VA388 (2-3 Gr.) .....	112



## 1. MACHINE DESCRIPTION

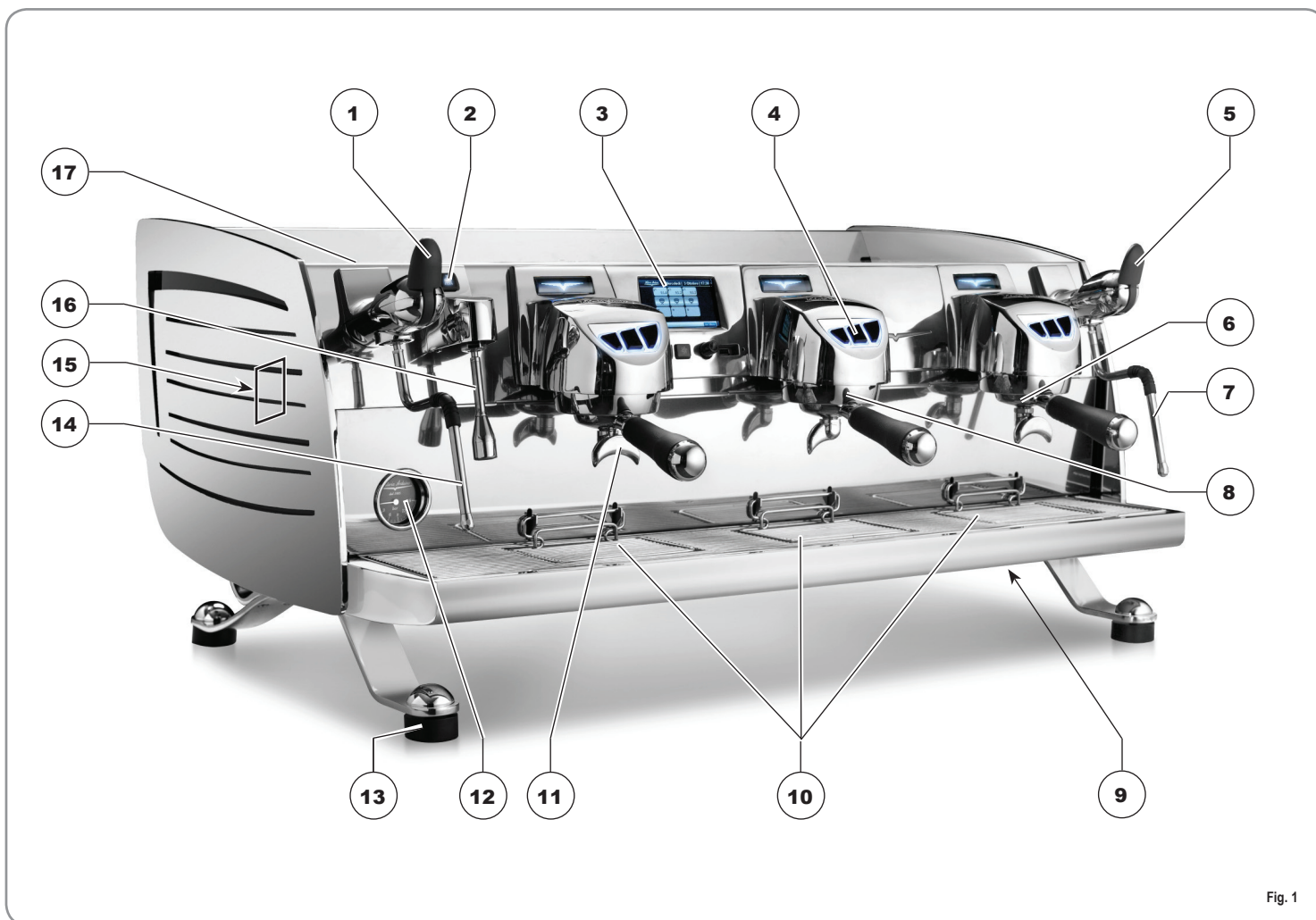

Fig. 1

### KEY

- 1 Steam knob
- 2 Hot water dispensing button
- 3 Control panel
- 4 Coffee delivery buttons
- 5 Steam knob
- 6 Filter-holder
- 7 Manual steam nozzle

- 8 Delivery unit
- 9 Main switch
- 10 Gravimetric devices
- 11 2 coffees spout
- 12 Pressure Gauge
- 13 Adjustable foot
- 14 Manual steam nozzle

- 15 Data plate
- 16 Hot water nozzle
- 17 Electric cup warmer (optional)

## 1.1 CONTROL PANEL DESCRIPTION

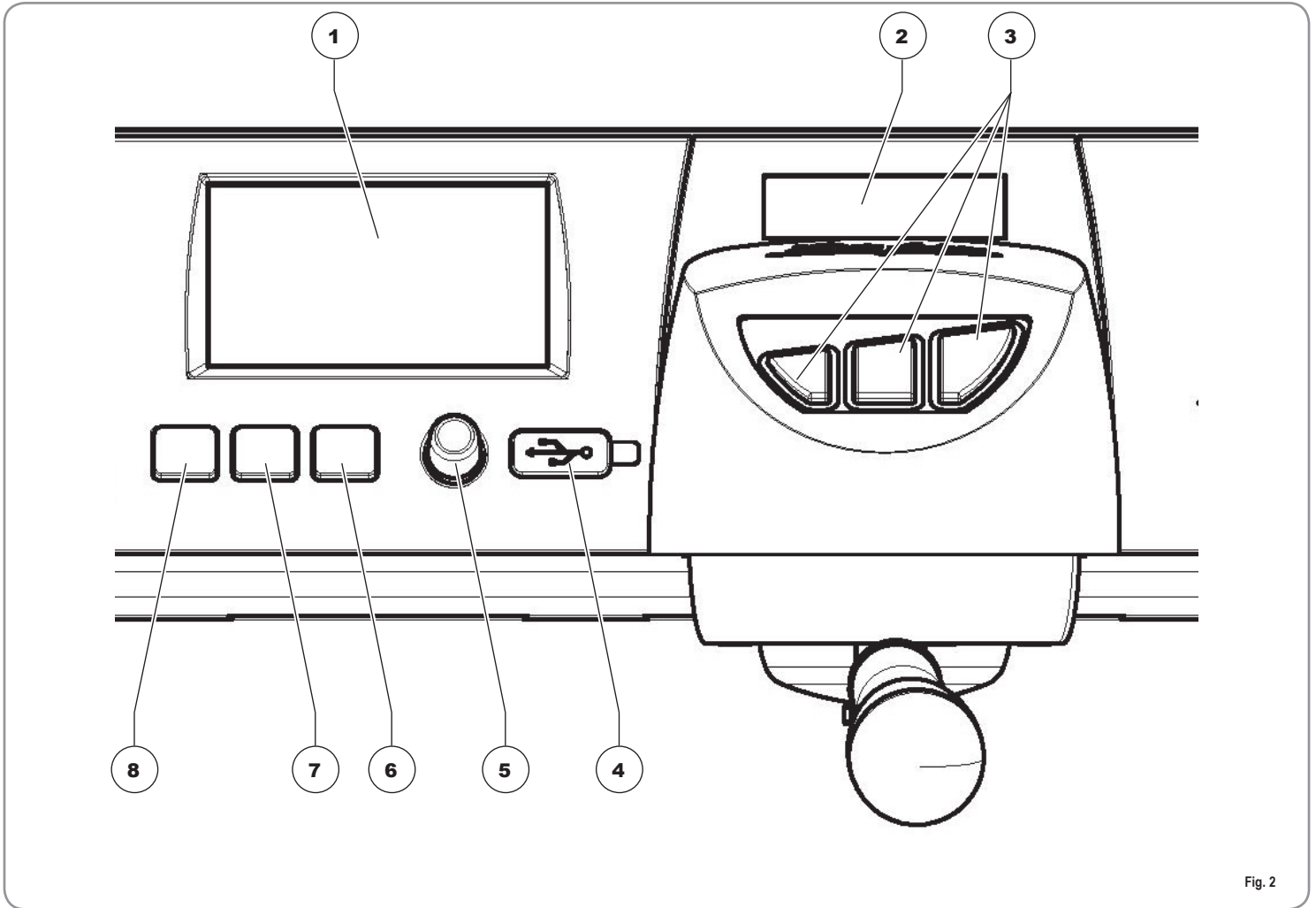

Fig. 2

### KEY

- |   |                        |   |                          |
|---|------------------------|---|--------------------------|
| 1 | TFT display            | 7 | Cup warmer ON/OFF button |
| 2 | Group display          | 8 | Machine ON/OFF button    |
| 3 | Coffee pour containers |   |                          |
| 4 | USB port               |   |                          |
| 5 | Rotary switch          |   |                          |
| 6 | Wash button            |   |                          |

## 1.2 ACCESSORIES LIST

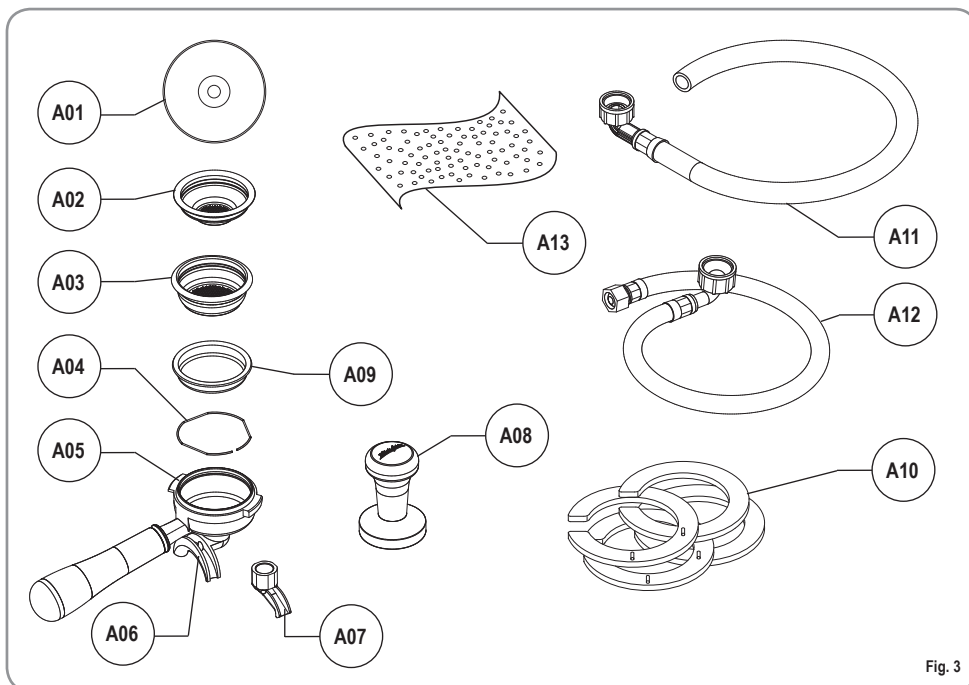





Fig. 3

CODE	DESCRIPTION	2 GROUPS	3 GROUPS
A01	DVD	1	1
A02	Single filter	1	1
A03	Double filte	2	4
A04	Spring	3	5
A05	Filter-holder	1	1
A06	Double delivery spout	2	3
A07	Single delivery spout	1	1
A08	Coffee presser	1	1
A09	Blind filter	1	1
A10	Cable strip (optional)	10	10
A11	Waist pipe 3/4"	1	1
A12	Filling tube 3/8"	1	1
A13	Microfibre cloth	1	1

## 2. SAFETY PRESCRIPTION

-  This book is an integral and essential part of the product and must be given to the user. Read this book carefully. It provides important information concerning safety of installation, use and maintenance. Save it carefully for future reference.

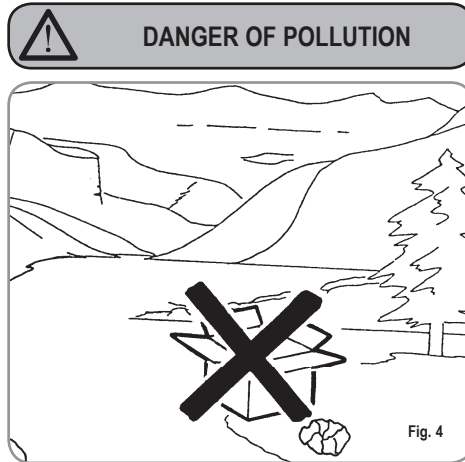

-  The illustrations in this manual are purely for information purposes. Your machine may differ slightly from the one shown here. Victoria Arduino reserves the right to make any changes to products and the manual without the need for any updates to previous products and manuals.

-  After unpacking, make sure the appliance is complete. In case of doubts, do not use the appliance, but consult a qualified technician. Packaging items which are potentially dangerous (plastic bags, polystyrene foam, nails, etc..) must be kept out of children's reach and must not be disposed of in the environment.

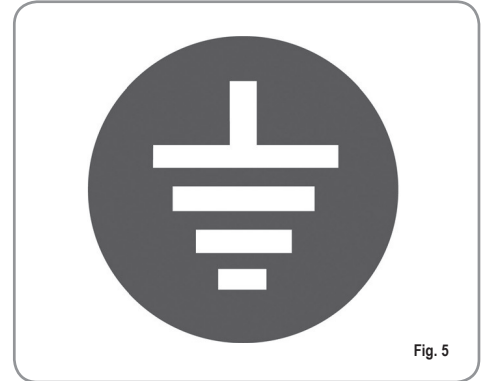

-  Before connecting the appliance make sure the rating plate data correspond with the mains. The plate is located on the left side of the machine, under the body. The appliance must be installed by qualified technicians in accordance with current standards and manufacturer's instructions. The manufacturer is not liable for any damage caused due to failure to ground the system. For the electrical safety of the appliance, it is necessary to equip the system with the proper grounding. This must be carried out by a qualified electrician who must ensure that the electric power of the system is sufficient to absorb the maximum power input stated on the plate.



-  In particular you must ensure that the size of the wiring cables is sufficient to absorb power input. The use of adapters, multiple sockets or extensions is strictly forbidden. If they prove necessary, call a fully qualified electrician.
-  For appliances powered at 220-230 V, the maximum impedance from the mains must be no higher than 0.37 Ohm.
-  When installing the device, it is necessary to use the parts and materials supplied with the device itself. Should it be necessary to use other parts, the installation engineer needs to check their suitability for use in contact with water for human consumption.

☞ The machine must be installed in compliance with the local health standards in force for plumbing systems. Therefore, contact an authorized plumber.

☞ The device needs to be supplied with water that is suitable for human consumption and compliant with the regulations in force in the place of installation. The installation engineer needs confirmation from the owner/manager of the system that the water complies with the requirements and standards stated above.

☞ This appliance must only be used as described in this handbook. The manufacturer shall not be liable for any damage caused due to improper, incorrect and unreasonable use

☞ This appliance is not suitable for use by children or persons with reduced physical, sensory or mental capabilities, or by persons with a lack of experience or knowledge, unless supervised or given instructions.

☞ The maximum and minimum storage temperatures must fall within a range of [-5, +50]°C.

☞ The operating temperature must be within the range of [+5, +35]°C.

☞ At the end of installation, the device is switched on and taken to rated operating conditions, leaving it in a state in which it is "ready for operation".  
The device is then switched off and the whole hydraulic circuit is bled of the first lot of water in order to remove any initial impurities.

The device is then refilled and taken to rated operating conditions.

After reaching the "ready for operation" condition, the following dispensing operations are carried out:

- 100% of the coffee circuit through the coffee dispenser (for more than one dispenser, this is divided equally);
- 100% of the hot water circuit through the water dispenser (for more than one dispenser, this is divided equally);
- opening of each steam outlet for 1 minute.

At the end of installation, it is good practice to draw up a report of the operations.

☞ Basic rules must be observed when using any electric appliance.

In particular:

- do not touch the appliance when hands or feet are wet;
- do not use the appliance when barefoot;

**CAUTION**  
**RISK OF ELECTRIC SHOCK**

- never use extension cords in rooms used as wash or shower rooms;
- do not pull the supply cord out of the socket to disconnect it from the mains;
- do not leave the appliance exposed to atmospheric agents (rain, sun, etc.);
- do not let the appliance be used by children, unauthorised staff or staff who have not read and fully understood the contents of this handbook.

☞ During installation, the mains power system needs to be equipped with a disconnecter switch to cut off each phase.

☞ Before carrying out any maintenance operation, the authorised service engineer will switch off the machine and open the disconnecter.

☞ For all cleaning operations comply exclusively with the instructions given in this booklet.

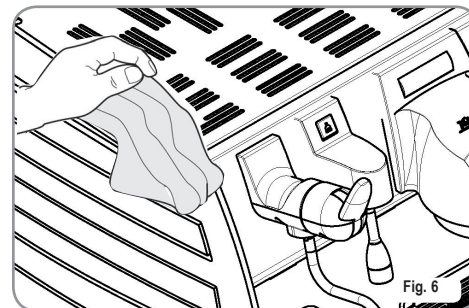

☞ If the appliance breaks down or fails to work properly, switch it off. Any intervention is strictly forbidden.

Repairs should only be made by the manufacturer or authorized vice centres.

Only original spare parts must be used.

Failure to observe the above, could make the appliance unsafe.

☞ For installation, the qualified electrician must fit an omnipolar switch in accordance with the safety regulations in force and with 3 (0,12) or more mm (in) between contacts.

☞ To avoid dangerous overheating, make sure the supply cord is fully uncoiled.

☞ Do not obstruct the extraction and/or dissipator grids, especially of the cup warmer.

☞ The user must not replace the appliance supply cord. If the cord is damaged, switch off the appliance and have a qualified technician change the cord.

☞ Single-phase appliances with current above 15 A and three-phase appliances sold without plugs are directly wired to the mains power and therefore, it is not possible to use a plug.

☞ If no longer using the appliance, we recommend making it inoperative; after removing the plug from the mains electricity, cut the power supply cable.

**CAUTION**  
RISK OF POLLUTION

☞ Do not dispose of the machine in the environment; for the disposal, contact an authorized service center or contact the manufacturer for indications.

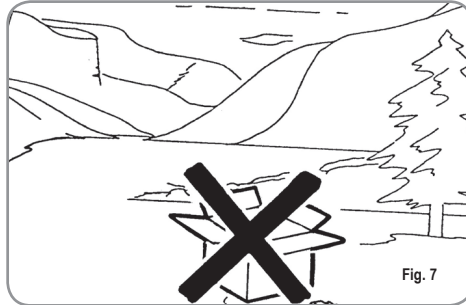

**CAUTION**  
RISK OF POLLUTION

☞ Use the steam nozzle with care and never place hands below the jet of steam. Do not touch the nozzle immediately after us.

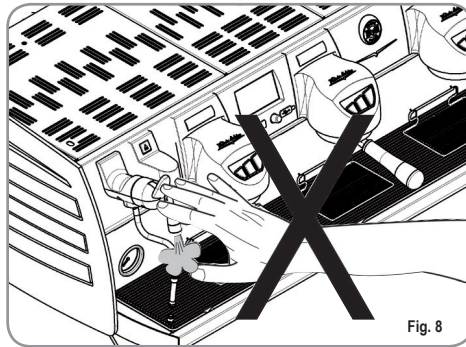

**CAUTION**  
RISK OF INTOXICATION

☞ We remind you that before carrying out any installation, maintenance, unloading or adjustment operations, the qualified operator must put on work gloves and protective footwear.

☞ The maximum noise disturbance level is lower than 70db.

☞ If the pipe connecting to the mains water is replaced the old pipe must never be re-used.

**CAUTION**

**INFORMATION TO THE USERS**  
Under the senses of art. 13 of Law Decree 25th July 2005, n. 151 "Implementation of the Directives/ Guidelines 2002/95/CE, 2002/96/CE and 2003/108/CE, concerning the reduction of the use of dangerous substances in electric and electronic equipment, as well as the disposal of wastes".

The symbol of the crossed large rubbish container that is present on the machine points out that the product at the end of its life cycle must Be collected separately from the other wastes. The user for this reason will have to give the equipment that got to its life cycle to the suitable separate waste collection centres of electronic and electrotechnical wastes, or to give it back to the seller or dealer when buying a new equipment of equivalent type, in terms of one to one. The suitable separate waste collection for the following sending of the disused equipment to recycling, the dealing or handling and compatible environment disposal contributes to avoid possible negative effects on the environment and on the people's health and helps the recycling of the materials the machine is composed of. The user's illegal disposal of the product implies the application of administrative fines as stated in Law Decree n.22/1997" (article 50 and followings of the Law Decree n.22/1997).

### 3. TRANSPORT AND HANDLING

#### 3.1 MACHINE IDENTIFICATION

Always quote the machine serial number in all communications to the manufacturer, **Victoria Arduino**.

Victoria Arduino Since 1985

Mod. VA388 T3 S GR2 C

S.N. XXXXXX	Date 09 / 03 / 2015
380 - 415 V3N ~	P = 7400 W
50 / 60 Hz	Cup Warmer

Operating Pressure 0,165 MPa MAX Inlet Pressure 0,65 Mpa

**BELFORTE DEL CHIENTI (MC)**  
MADE IN ITALY

Fig. 9

#### 3.2 TRANSPORT

The machine is transported on pallets which also contain other machines - all boxed and secured to the pallet with supports.

Before carrying out any transport or handling operation, the operator must:

- put on work gloves and protective footwear, as well as a set of overalls which must be elasticated at the wrists and ankles.
- The pallet must be transported using a suitable means for lifting (e.g., forklift).

#### 3.3 HANDLING

**CAUTION**  
RISK OF IMPACT  
OR CRASHING

Must ensure that there are no persons, objects or property in the handling area.

The pallet must be slowly raised to a height of 30 cm (11,8 in) and moved to the loading area. After first ensuring that there are no persons, objects or property, loading operations can be carried out.

Upon arrival at the destination and after ensuring that there are no persons, objects or property in the unloading area, the proper lifting equipment (e.g. forklift) should be used to lower the pallet to the ground and then to move it (at approx. 30 cm (11,8 in) from ground level), to the storage area.

**CAUTION**  
RISK OF IMPACT  
OR CRASHING

Before carrying out the following operation, the load must be checked to ensure that it is in the correct position and that, when the supports are cut, it will not fall.

The operator, who must first put on work gloves and protective footwear, will proceed to cut the supports and to storing the product. To carry out this operation, the technical characteristics of the product must be consulted in order to know the weight of the machine and to store it accordingly.

### 4. INSTALLATION AND PRELIMINARY OPERATIONS

Once the machine is out of the packaging and its integrity, and that of the accessories has been checked, place it on a flat, horizontal surface and if necessary, use the adjustable feet to make sure it is correctly level:

- Turn the feet to the left to raise the machine up to a maximum of + 1 cm;
- Turn the feet to the right to lower the machine.

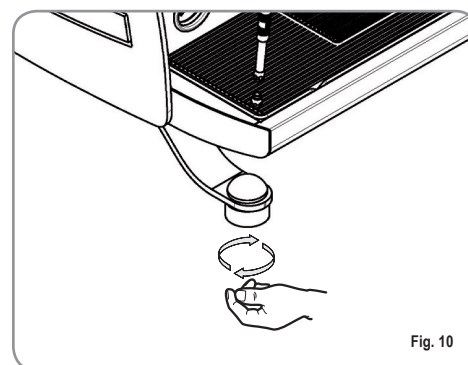

It is advisable to install a softener (1) and then a mesh filter (2) on the external part of the plumbing system, during preliminaries and after levelling the machine.

In this way impurities like sand, particles of calcium, rust etc will not damage the delicate graphite surfaces and durability will be guaranteed.

Following these operations, connect the plumbing systems as illustrated in the following figure.



**WARNING**

Avoid throttling in the connecting tubes. Assess that the drain pipe (3) is able to eliminate waste.

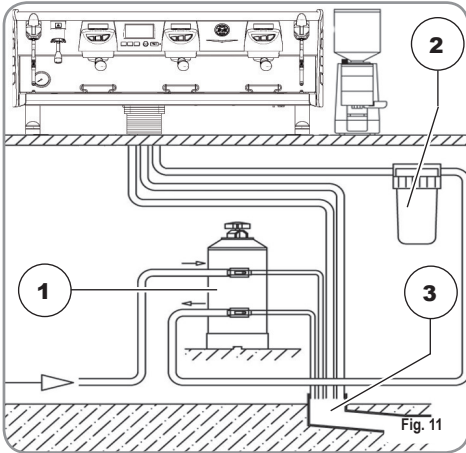

- KEY**
- 1 Softener
  - 2 Mesh filter
  - 3 Drain Ø 50 mm

**4.1 CABLE STRIP COVERING (optional)**

Once the machine has been levelled and connected to the power and water mains, use the cable strips (optional) to cover up the wiring, as shown in the figure.



Fig. 12

**4.2 WATER SPECIFICATIONS**

Monitoring of water recipe to keep it within required levels and maintenance of filtration system is the user's responsibility.

Failing to meet and maintain water at the following levels will void the entire warranty:

- total hardness 50-60 ppm (parts per million)
- water line pressure between 2 – 4bar and water to be cold
- min flow rate: 200 l/hr
- filtration level below 1.0 micron
- tds (total dissolved solids) level between 50 – 250 ppm
- alkalinity level between 10 – 150 ppm
- chlorine level less than 0.50 mg/l
- Ph level between 6.5 and 8.5.

**4.3 ELECTRICITY SPECIFICATIONS**



**CAUTION RISK OF SHORT CIRCUITS**

The machine must always be protected by an automatic omnipolar switch of suitable power with contact openings of equal distance or more than 3mm.

Victoria Arduino is not liable for any damage to people or objects due to not observing current security measures.

Prior to connecting the machine to the electrical mains, assess that the voltage shown on the machine's data plate corresponds with that of the mains.

If it does not, carry out the connections on the basis of the available electrical line, as follows:

- for **V 380** / 3 phases voltage + Neutral:

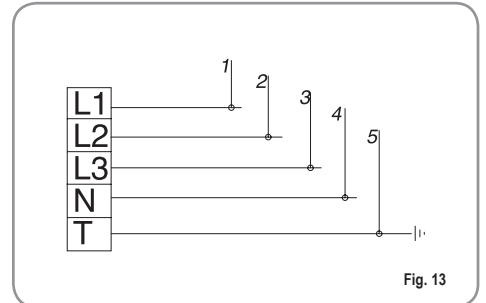

Fig. 13

- for **V 230** / monophase voltage

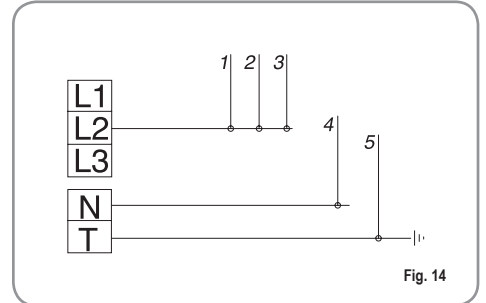

Fig. 14

- KEY**
- |         |                |
|---------|----------------|
| 1 Black | 4 Blue         |
| 2 Grey  | 5 Yellow-green |
| 3 Brown |                |

**NOTE:** At the start of the day's activities and in any case, if there are any pauses of more than 8 hours, then it is necessary to change 100% of the water in the circuits, using the relevant dispensers.

**NOTE:** In case of use where service is continuous, make the above changes at least once a week.



## 5. ADJUSTMENTS TO BE MADE BY A QUALIFIED TECHNICIAN ONLY

### 5.1 HOT WATER ECONOMISER ADJUSTMENT

**NOTE:** this operation can be carried out while the machine is turned on.

All models  are fitted with a hot water mixer, which serves to adjust the temperature of the water leaving the wand and to optimise system performance.

To set the hot water economy device, use a screwdriver on the screw in the top part of the machine, as shown in the figure.

- Turn it **CLOCKWISE** / **ANTICLOCKWISE** to **REDUCE** / **INCREASE** the temperature of the hot water;

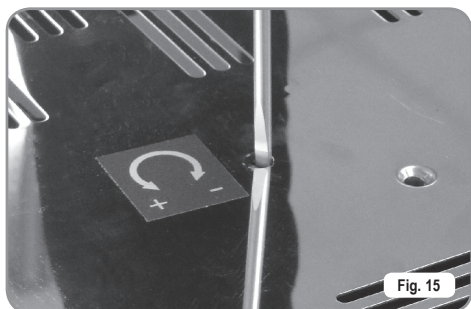



### 5.2 REPLACING THE CLOCK BATTERY

The electronic control unit has a lithium battery to power the clock; the battery has an autonomy of about three years, after which it will need to be replaced.

In case of an extended period of machine stoppage, the clock can be stopped:

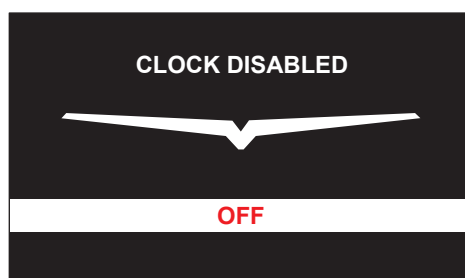
- with the machine off the display will read:



- hold the ON/OFF key down  for 5 sec. to release the clock.



Replacement of the lithium battery must be carried out **EXCLUSIVELY** by Qualified Technician.



Victoria Arduino cannot be held liable for any damage to people or things due to non observance of the safety prescriptions described in this booklet.

## 6. USE

Before starting to use the appliance, the operator must be sure to have read and understood the safety prescriptions contained in this booklet.

### 6.1 COMMISSIONING PROCEDURE OR AFTER BOILER MAINTENANCE

When commissioning the machine for the first time or after carrying maintenance switch ON the machine using the main switch positioned lower down and on the right and proceed as follows:

- 1) If the message "OFF - CLOCK DISENABLED" appears on the display proceed as follows in step three.
- 2) If the display reads "OFF" press the ON/OFF  key until it reads "OFF -CLOCK DISABLED" and then proceed as described in step 3.
- 3) Switch on the machine using the ON/OFF  key and automatically after the machine has switched on, some water will be poured from the groups for about 45 seconds to make sure that the coffee boiler tanks have been properly filled.

**This cycle cannot and must not be interrupted.**

If this cycle is interrupted due to a power outage or if the machine is accidentally switched off from the main switch, the next time the machine is switched on, the cycle will be started again for approximately 45 seconds more.

### 6.2 SWITCHING THE MACHINE ON/OFF

**SWITCH ON:** plug the machine into the power socket and press the switch "A" so it is in position "I"; the machine will switch on.

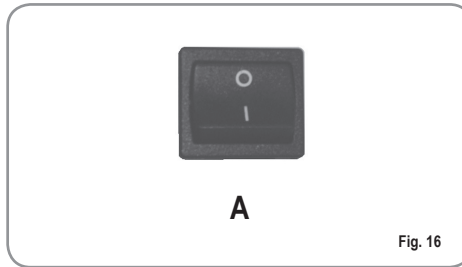

**If the self-diagnostics report anomalies or failures, the operator MUST NOT intervene. Please contact the Assistance Centre.**

- The lit display will show the firmware version for about 1 second:



- The display, which is not illuminated, will read:

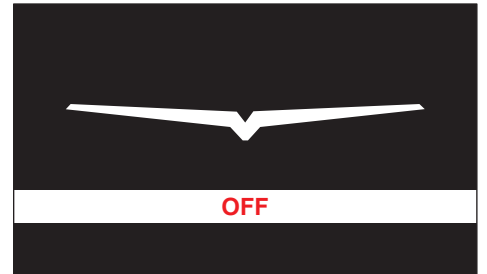

**NOTE:** The machine is not operational, since the main switch only powers the electronic card.



**For electronic card maintenance, turn the machine off by means of the external main switch or disconnect the plug.**

#### MANUAL SWITCHING ON/OFF

**Automatic On/Off NOT PROGRAMMED**

**NOTE:** make sure that the general switch is always on the position "I".

**SWITCH ON:** press the ON/OFF button  for about 2 seconds until the light switches on and the buzzer makes a beep sound. The control unit will start up an auto diagnosis cycle to check the functions, all the selection keys will light up.

After the diagnostics stage, the "Home Page" will open on the screen:



**NOTE:** on completion of the check up all the selection keys are activated.



**WARNING**

In case the auto diagnosis indicates error or malfunction, call an assistance centre; the operator **MUST NOT** intervene.

**SWITCHING OFF:** press the ON/OFF button  for about 2 seconds, until the light switches off. The machine will switch off and the display will read:

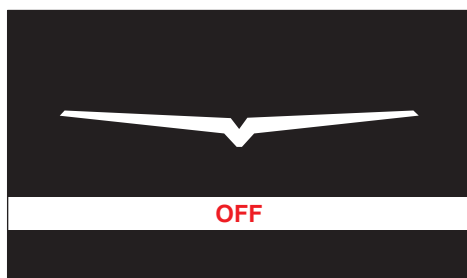

**Automatic On/Off PROGRAMMED**

**NOTE:** make sure that the general switch is always on the position "I".

The machine will **SWITCH OFF** at the first time set for stopping the coffee maker (see the **PROGRAMMING** chapter and the **ENERGY SAVING** section).

The control unit will perform an auto diagnosis of all functions and all of the selection keys will light up. After the diagnostics stage, the "Home Page" will open on the screen:



**NOTE:** once the auto diagnosis has been completed all the keys are activated.



**WARNING**

If the self-diagnostics report anomalies or failures, the operator **MUST NOT** intervene. Please contact the Assistance Centre.

The machine will **SWITCH ON** at the first programmed switch-on time (see the **PROGRAMMING** chapter and the **ENERGY SAVING** section).

**NOTE:** the machine can be switched on or off manually as indicated in the previous paragraph.

**6.3 MAKING COFFEE**

Unhitch the filter-holder and fill it with one or two doses of ground coffee depending on the filter used.

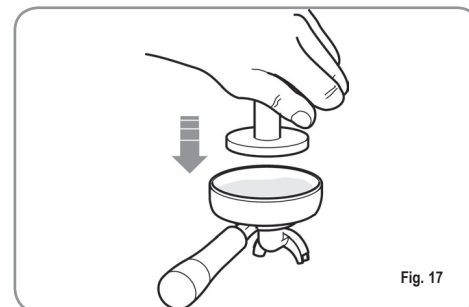

Fig. 17

Press the coffee with the provided coffee presser, dust off any coffee residue from the rim of the filter (this way the rubber gasket will last longer).

Insert the filter in its unit. Press the desired coffee button.

**NOTE:** when in pause, leave the filter-holder inserted in the unit so that it will keep warm.

To guarantee the utmost thermic stability during use, the delivery units are thermo-compensated with complete hot water circulation.

## 6.4 USING STEAM (Manual steam wand)



**CAUTION**  
RISK OF BURNS OR SCALDING

While using the steam nozzle, you must pay attention to not place your hands beneath it or touch just after it has been used.

To use the steam function, pull or push the relevant lever, as shown in the figure.

By pulling it completely the lever will hold a position of maximum delivery; by pushing it, the lever will automatically give way.

The two steam nozzles are articulated to guarantee their easy use.

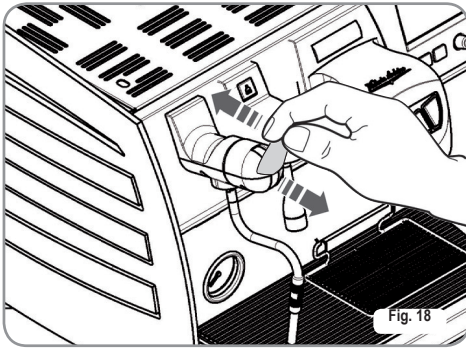

**NOTE:** Before using the steam wand, always bleed out any condensation for at least 2 seconds or according to the manufacturer's instructions.

## 6.5 MAKING CAPPUCCINO

To obtain the typical cappuccino foam, immerse the nozzle all the way into a container 1/3 full of milk (preferably cone-shaped). Turn on the steam. Before the milk starts to boil, pull the nozzle slightly up and lightly move it vertically across the surface of the milk. When you have completed the procedure, clean the nozzle carefully with a soft cloth.

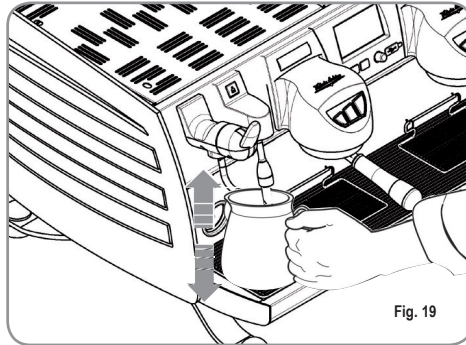

## 6.6 HOT WATER SELECTION



**CAUTION**  
RISK OF BURNS OR SCALDING

While using the hot water nozzle, pay careful attention not to place your hands beneath it or touch it just after it has been used.

This nozzle delivers hot water to make tea or herb teas.

Place a suitable container under the hot water nozzle. Press the hot water select button once;

the light  will switch on.

The hot water wand will deliver water for the amount of time equivalent to the set value (see PROGRAMMING section and the DOSE PROGRAMMING section) or press the button again to stop pouring.

**NOTE:** Hot water can be delivered at the same time as coffee.

## 7. PROGRAMMING

### 7.1 KEY

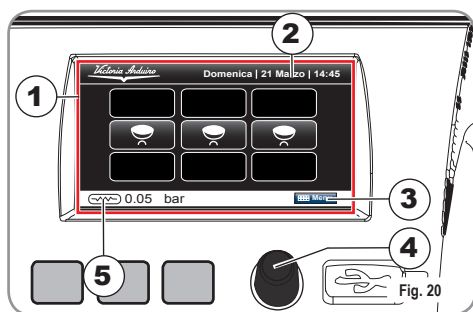

Nr.		Description
1		Interactive programming / viewing area.
2		<b>DATE and TIME</b>
3		<b>MENU ICON</b> To open the main menu and return back a level during navigation.
4		<b>ROTARY SWITCH:</b> Turn to move through the interface. When the icon is selected, it changes colour and lights up white; press to enable the selected function/icon. Programming also makes it possible to increased and/or reduce settings.
5		<b>HOME ICON</b> To return to the "Home Page" while navigating through the interface.

## 7.2 PROGRAMMING

Switch on the machine as described in the "Use" chapter – the "Switching the machine On/ Off" section. The display shows the "Home Page".

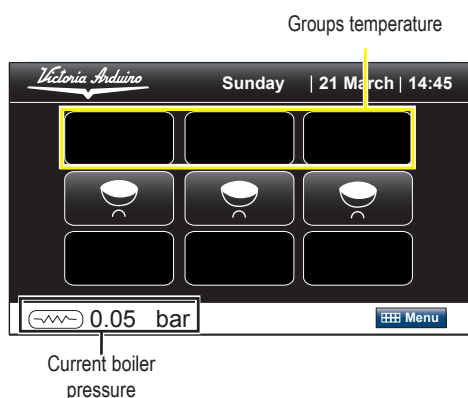

Select and press the rotary switch to access the main menu.



Icon	Description
	Language.
	Dose programming.
	Setpoint temperature and group/boiler offset.
	Key and display settings.
	Energy saving.
	Delivery counts.
	Alarms.
	Technical settings.

### 7.2.1 LANGUAGE

Use the rotary switch to move to the "Language" icon. Press the icon to open:



This shows the page for selecting the language for the whole interface.



Use the rotary switch to move within the screen and press to confirm the language selection.



### 7.2.2 DOSE PROGRAMMING

Use the rotary switch to move to the "Dose Program." icon and press to open:







In the volumetric version, 3 options are shown :



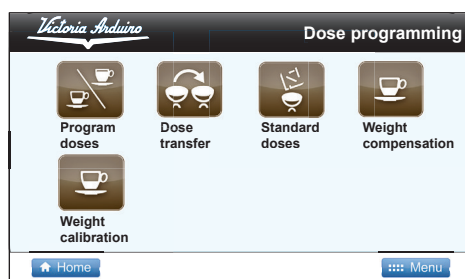

Icon	Description
	Programming single doses.
	Dose transfer between groups.
	Standard dose setting.

In the gravimetric version, 5 options are shown:



Icon	Description
	Programming single doses.
	Dose transfer between groups.
	Standard dose setting.

Icon	Description
	Weight compensation (*).
	Weight calibration (*).

(\* ) Present in the gravimetric version only.

Use the rotary switch to select one of the three options and then press to access.

### DOSE PROGRAMMING

The display will show:

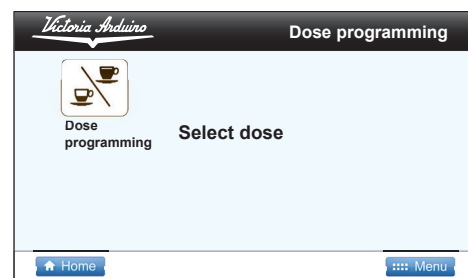

Select the icon  again with the rotary switch and press.

All programmable keys will start to flash:

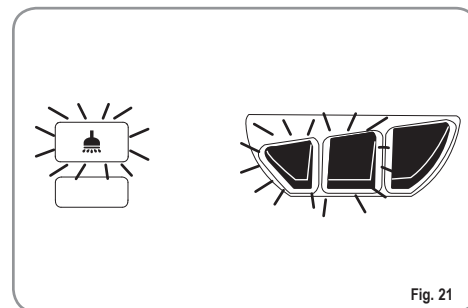
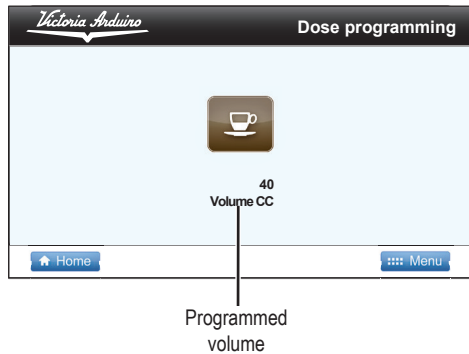

Fig. 21

**Coffee:**

Press the button to be programmed; the display will show the icon for the selected button and the setting already programmed.



It is possible to change the dose using the rotary switch and then pressing it to confirm the setting. Or, press the coffee key to programme, the delivery will start and in the meantime, all of the other lights will switch off. Once the required dose has been poured, press the continuous

coffee button  to stop delivery.

- The display will show the new value and it will still be possible to change it using the rotary switch.
- Press the rotary switch in any case to confirm the programmed dose.
- The coffee button that has been programmed is then switched off by pressing the rotary switch.

**NOTE:** The volumetric version VA388 measures the water volume getting into the machine during pouring (cl).  
The gravimetric version VA388 measures the weight (g) of the liquid contained in a cup with a tolerance of  $\pm 1g$ .

To continue programming the different keys, select the icon with the rotary switch and press on it.



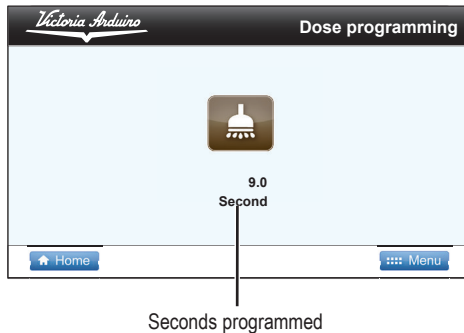

**Hot water:**

Press the hot water button  to be programmed; the display will show the icon for the chosen function and the programmed setting.



It is possible to change the dose using the rotary switch and then pressing it to confirm the setting.

Or, press the hot water key  to programme, the delivery will start and in the meantime, all of the other lights will switch off.

Once the required dose has been poured, press the hot water button  to stop delivery.

- The display will show the new value and it will still be possible to change it using the rotary switch.
- Press the rotary switch in any case to confirm the programmed dose.
- The hot water button that has been programmed is then switched off by pressing the rotary switch.

**DOSE TRANSFER** :

This function serves to transfer the value of the programmed dose settings to other groups. Select the group to be used as a "source" and confirm:



Select the "destination" group for the copy of the settings and confirm

**NOTE:** The group used as a source is uninhibited.



**STANDARD DOSES** :

This function serves to recall the "Standard dose" settings for groups.

The display shows:

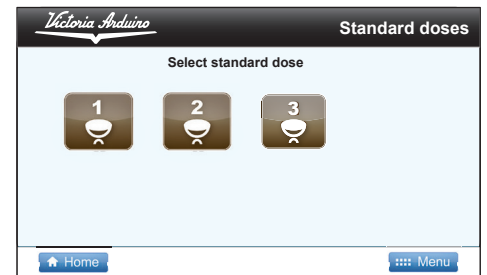

Select the coffee unit to apply the "standard dose" settings and press the rotary switch to confirm.

**WEIGHT COMPENSTATION**   
(for gravimetric version only):



By using this function, a weighing compensation value can be introduced.

This parameter allows to obtain the actually set value at the end of pouring: since the coffee keeps on coming out when the group electrovalve is closed, the amount measured in the cup is slightly larger than the one set during programming.

Every coffee has its own specific compensation based on its features. The amount to compensate depends on pouring: it will have a different value for a pouring of single coffee and double coffee.

By setting this parameter, the machine will stop pouring in advance, according to the compensation value set.

The compensation value may vary from 0.0 g to 5.0 g, with variations of 0.5 g.

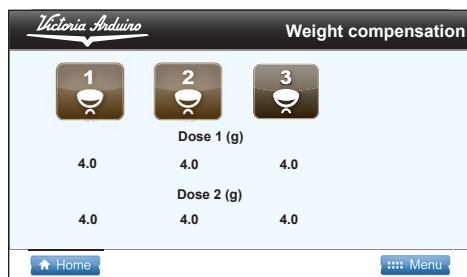

**WEIGHT CALIBRATION** 

The calibration function was added to have an univocal correspondence with a external, potential scale of reference.  
Select the group to calibrate.



Press the rotary switch to select the group to calibrate.

1. Rotate the rotary switch to increase/reduce the weight;
2. Select a 100 g delivery of coffee.



In the first case, just rotate the rotary switch up to the required value.

**EXAMPLE:** The external scale always reads two grams more than the displayed value: the calibration value must be set at 98 g.



In the second case, carry out a specific pouring, as follows:

1. the tare of a container of at least 120 g with the external scale.
2. Insert some coffee in the filter holder and put the container on the grid.
3. Confirm the calibration.

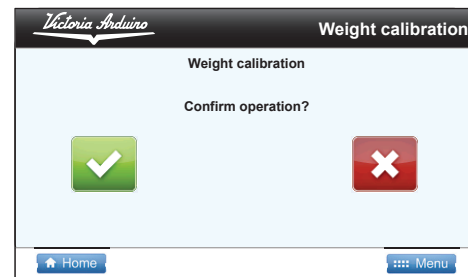

The machine will deliver up to 100 g. The value shown may be slightly larger. At this point, check the correspondence between the value shown on the group (e.g. 102) and the reference one of the external scale (e.g. 104). Add the value shown on the machine, and then set the calibration at 102 g.



### 7.2.3 SET POINT

#### TEMPERATURE



Use the rotary switch to move to the "Set point temperature" and press to enter:



4 options will be displayed:



Icon	Description
	Group setpoint
	Setpoint caldaie
	Steam boiler setpoint.
	Cup warmer..

#### GROUP SETPOINT



The display will show:

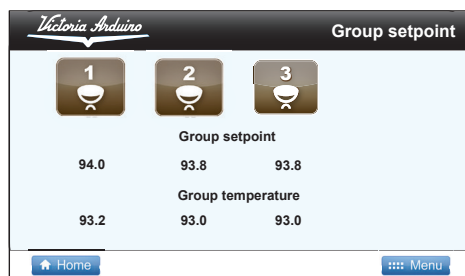

Use the rotary switch to select the coffee group to adjust and confirm by pressing.

Group 1 example:

Setting programmed / to be programmed

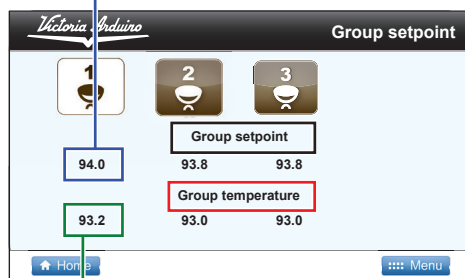

Instant setting

Turn the rotary switch to select the required temperature for the group, then press to confirm.

#### GROUP OFFSET ADJUSTMENT:

From the screen:

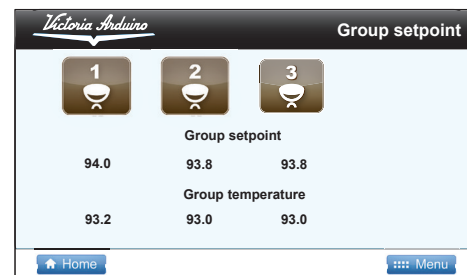

Hold down the washing key to access offset and group temperature adjustment.

The next screen will be:

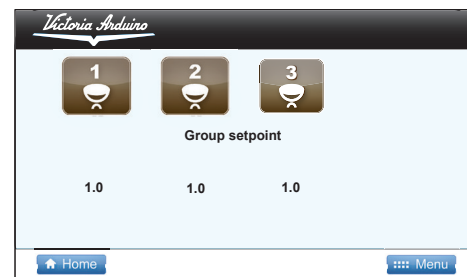

With the rotary switch it is possible to select the group offset to be adjusted and press to proceed.

Use the rotary switch to adjust the value of the group offset and then confirm with by pressing the switch.

At this point, it is possible to adjust the offset of the other groups with the same procedure or to select or .

This setting is reserved to qualified service engineers.

## BOILER SETPOINT

The display shows:

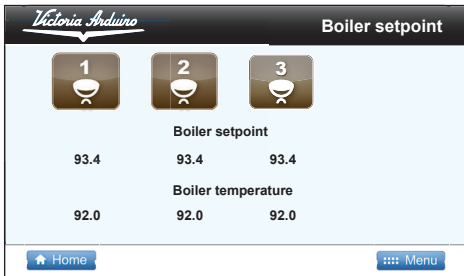

Select the coffee boiler to be adjusted and confirm by pressing the rotary switch.

Boiler 1 example:

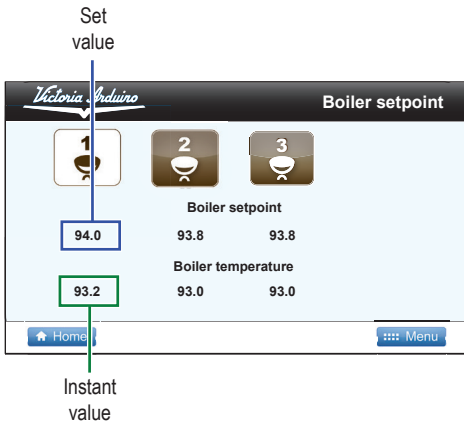

Turn the rotary switch to select the required temperature for the group; press it to confirm the setting.

## BOILER OFFSET ADJUSTMENT:

From the screen:

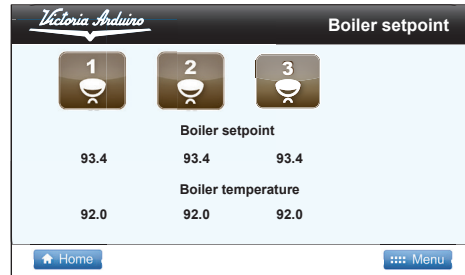

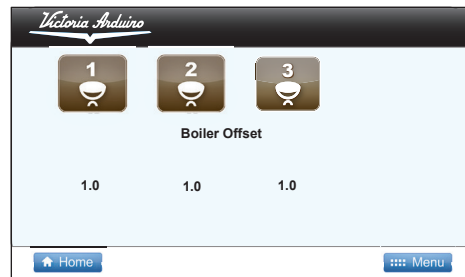

Hold down the washing key  to access offset and boiler temperature adjustment.

The next screen will be:



Use the rotary switch to select the coffee boiler for offset adjustment and press it to proceed. Also use the rotary switch to set the offset value for the group and then press the switch to confirm.

At this point it is possible to adjust the offset of other groups with the same procedure or select  Menu or  Home.

This setting is reserved to qualified service engineers.

## STEAM BOILER SETPOINT

The display shows:



Select the steam icon and confirm with the rotary switch.

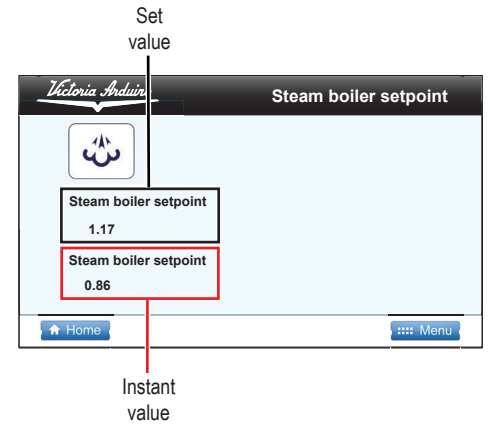

Turn the rotary switch to select the required pressure / temperature for the boiler (see the table on the following page) and then press the switch to confirm the setting.

PRESSURE-TEMPERATURE TABLE		
Bar	°C	°F
0,50	110,5	230,9
0,55	111,5	232,7
0,60	112,5	234,5
0,65	113,5	236,3
0,70	114	237,2
0,75	115	239
0,80	115,5	239,9
0,85	116,5	241,7
0,90	117,5	243,5
0,95	118	244,4
1,00	119	246,2
1,05	119,5	247,1
1,10	120,5	248,9
1,15	121	249,8
1,20	122	251,6
1,25	122,5	252,5
1,30	123	253,4
1,35	124	255,2
1,40	124,5	256,1
1,45	125	257
1,50	126	258,8
1,55	126,5	
1,60	127	

### CUP WARMER

The display will read:

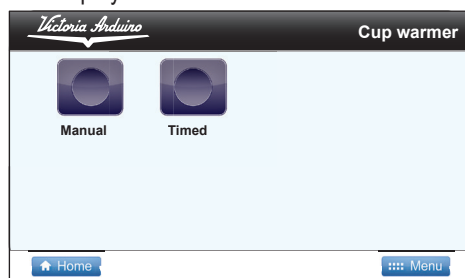

To work in "manual" mode, select the icon



Manual with the rotary switch and press:

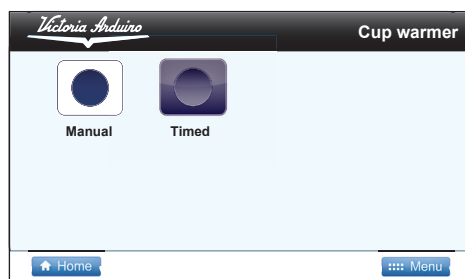

To work in "timer" mode, select the timer icon



Timed with the rotary switch and press it.

The following screen will open:



Use the rotary switch to edit the ON and OFF times and then press to confirm.

The selected ON and OFF buttons repeat cyclically.

## 7.2.4 KEY AND DISPLAY





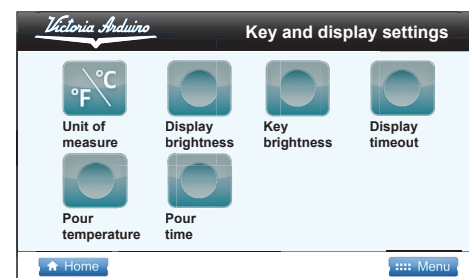

### SETTINGS

Use the rotary switch to move to the "Button and display setting" and press to open:



6 options will be displayed:



Icon	Description
	Unit of measurement
	Display brightness
	Button brightness
	Display timeout
	Delivery temperature
	Delivery time

**UNIT OF MEASURE** 

This screen serves to change the unit of measure for the temperature used to control the whole interface:

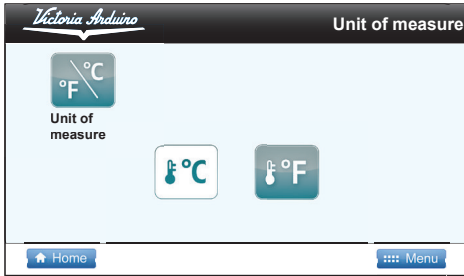

Use the rotary switch to select and press it to confirm.

**DISPLAY BRIGHTNESS** 

This function serves to adjust the standard brightness of the display:

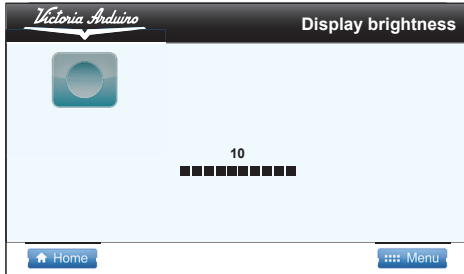

Use the rotary switch to choose the level and press it to confirm.

**BUTTON BRIGHTNESS** 

Use this function to set the brightness of the keys:

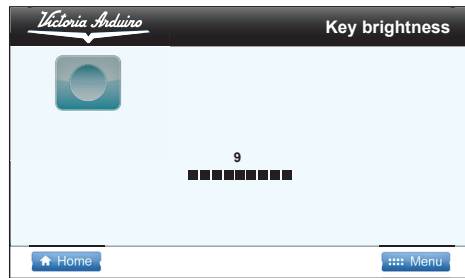

Use the rotary switch to choose the level and press it to confirm.

**NOTE:** Light intensity adjustment of the keys is visible in real time for one group only. The setting is then applied to the other groups, once confirmation has been given.

**DISPLAY TIME OUT** 

Use this function to set the display "Time-out" time (low-brightness display).

Example. Set to 5 min, if the machine is not used for more than 5 minutes, the display brightness will be reduced.

The brightness will return to normal as soon as the machine is used again.

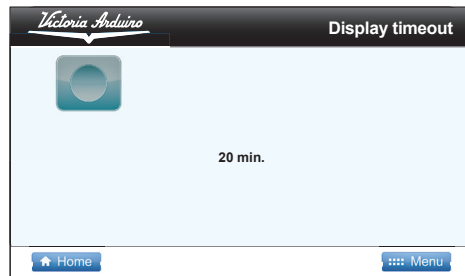



Use the rotary switch to choose the time (minutes) and press to confirm.

**DELIVERY TEMPERATURE** 

This function serves to activate/deactivate the display for the group delivery temperature on the "Home Page":



Use the rotary switch to select and press to confirm.  

**DELIVERY TIME** 

This function makes it possible to activate/deactivate viewing for the pouring time of a specific group on the screen:

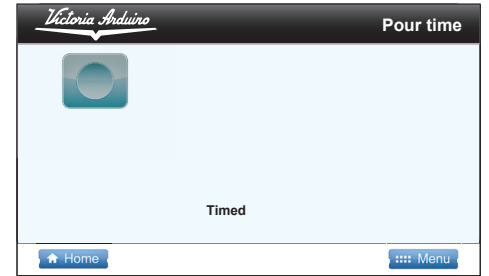

If you decide to view the delivery time , use the rotary switch to select from the following options:

- Timer (vanishes after 5 sec.);
- Persistent (remains on the display until the next coffee).

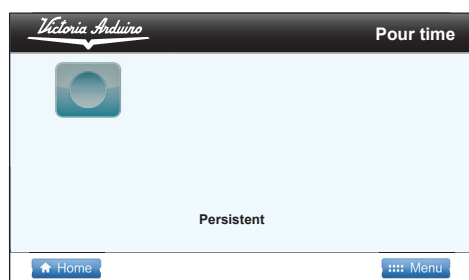

After selecting the option with the rotary switch, confirm by pressing.





### 7.2.5 ENERGY SAVING

Use the rotary switch to select the "Energy saving" icon and press to open the function:





This shows 4 options:



Icon	Description
	Weekly schedule.
	Active groups.
	Standby active.
	Power Management.



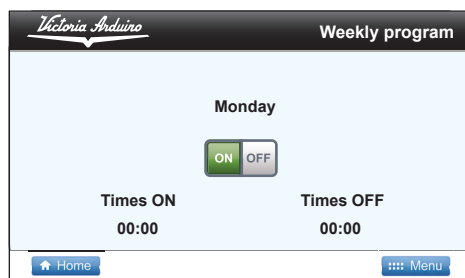

### WEEKLY PROGRAMMING

This page serves to set the days off for the machine and the days in which its automatic switch on and off functions are programmed. When the page is opened it will show the configuration of the first day of the week (Monday). Turn the rotary switch to view the configuration for the days until the last day of the week, after which select with the  and .

The operation is cyclical.



To change the configuration for one day, this day must be shown on the display and then the rotary switch must be pressed.

At this point, an icon  /  will be selected to signal if that day there is a programmed switch on or off time () or not ():

Programmable day example:

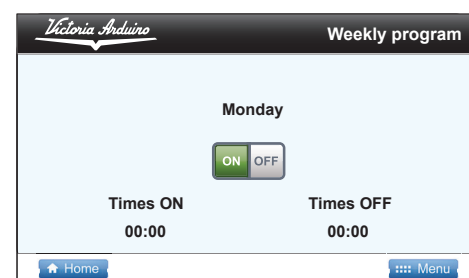

OFF day example:



To save changes, press the rotary switch. At this point, the day is active, the hours will start to flash for the ON time.

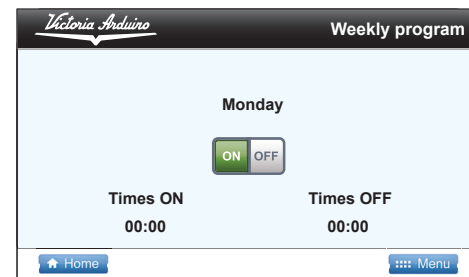

Turn the rotary switch to view and change the setting.

Press the rotary switch to store the setting and pass on to change the minutes for the ON time. The previous procedure is repeated with minutes and hours for the ON and OFF times.

Once the minutes have been saved for the OFF time, the machine returns to the initial condition where, by turning the rotary switch, it is possible to view the settings for the different days of the week, home and menu.

**ACTIVE GROUPS** 

This function serves to set the groups that are actually active when the machine is switched on:

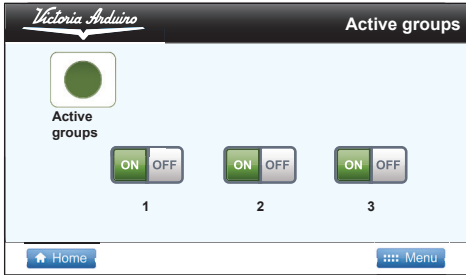

To set the active groups when the machine is switched on, proceed as follows:

- Access the function by pressing the rotary switch on the active group icon.
- It is possible to activate/deactivate individual groups using the rotary switch. Press the rotary switch to confirm and pass on to the next group. Confirming the last group will return to the menu.
- Press the icon  to go back to the home page.

**NOTE:** To make the change effective, it is necessary to quit the programming mode, switch the machine on and off from the main switch, which is located in the bottom right.

When the deactivated group is switched back on, its colour will be darker and the group will no longer be operational (e.g. group 1 deactivation).

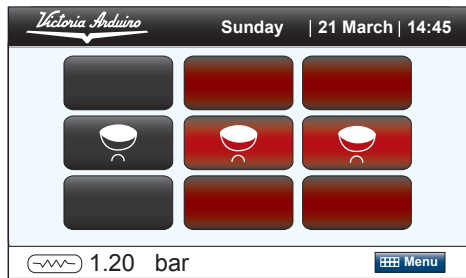

The change is permanent and can only be cancelled following the same procedure as used to enable it.

**TEMPORARY STANDBY:**

It is also possible to temporarily deactivate the groups without entering the programming mode. From the following stand-by screen:

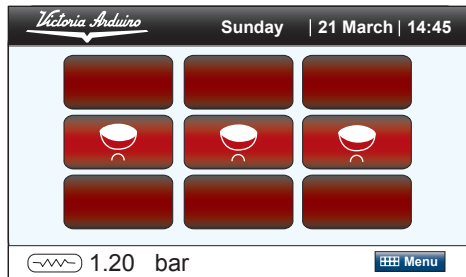

Press the  and central key of the group to be deactivated at the same time. The group will be deactivated and the display will read (E.g. group 1 deactivation):

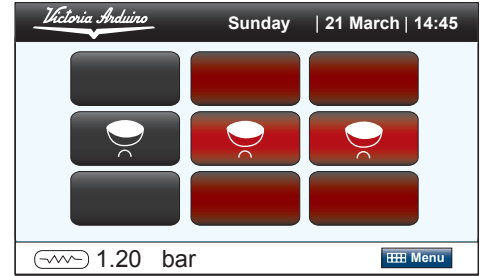

To reset this group, perform the above step or switch the machine off and on again, using the main switch, located in the bottom right.

**NOTE:** Switching off the group with a combination of keys is not permanent and each time the machine is switched off again, all the groups will be active.

**NOTE:** If a group is disabled, it is not possible to make any deliveries and the boiler heating elements will be switched off.

## ACTIVE STANDBY

This function allows the machine to enter standby mode or not, which makes it possible to choose whether or not to switch off the machine completely or to keep it at a set pressure (less than working levels).

Use the rotary switch to select the following options:

- **OFF**: during the OFF state, the machine is completely switched off and the display reads "OFF".



- **ON 0.10 bar**: during the OFF state, the machine maintains a pressure of 0.10 bar and the display (set to minimum brightness) reads "LOW CONSUMPTION".



- **ON 0.50 bar**: during the OFF state, the machine maintains a pressure of 0.50 bar and the display (set to minimum brightness) reads "LOW CONSUMPTION".

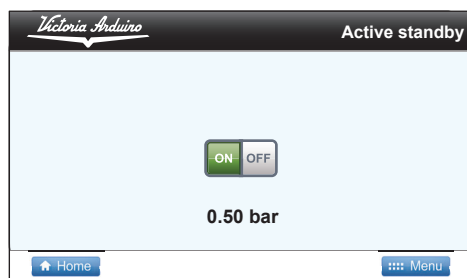

- **ON 0.80 bar**: during the OFF state, the machine maintains a pressure of 0.80 bar and the display (set to minimum brightness) reads "LOW CONSUMPTION".



Press the rotary switch to confirm the required option.

This operation is used with both manual switching on/off using the button , and automatic switching on/off by programming the machine.

If the on/off button  is pressed during one of the three active standby states (0.10 bar, 0.50 bar, 0.80 bar), the machine will switch off completely.

If the button is pressed again, this will switch on the machine.

## POWER MANAGEMENT

This function serves to control the power absorbed by the machine while it is heating up, in order to limit consumption.

If enabled at switch on, the use of the steam boiler, groups and group boiler will be split. The Power Management heating system will stop as soon as the steam boiler steam requirement drops to below 40% of maximum required power.

At this point, the machine will resume working as normal.

Use the dial to select  /  and then press to confirm.



**NOTE:** If the Power Management heating is enabled, the "Home Page" will show the following: "Eco warm-up".

### 7.2.6 DELIVERY COUNT

Use the rotary switch to move to the "Delivery count" icon and press to open:





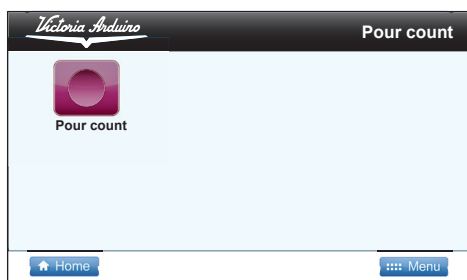



A screen will open to view the counters:







Select the delivery counter icon  and press the rotary switch.

On the counter page, it is possible to view 2 tables that show the counters; to pass from one to the other, use the rotary switch. The first table shows the counts for the single doses of each group:

	1 	2 	3 	
	5	0	0	
	0	0	0	
	0	0	0	
	0	0	0	
Continue	1	0	0	





The second table shows the total for groups, washing, services and absolute total:

	1 	2 	3 	
Total grp	6	6	6	
Washes	7	1	2	
Total				
	18	4	1	

he different fields in the two tables can be deleted using the delete mode.



The delete mode is entered by pressing and holding down the wash button  for a few seconds.

Once in this mode, the table will contain a red rectangle showing the value that can be deleted.

	1 	2 	3 	
Total grp	6	6	6	
Washes	7	1	2	
Total				
	18	4	1	

Use the rotary switch to select the field to be deleted and press the rotary switch again to delete it.

To quit the delete mode, press the wash button  again.

To quit the count mode, press the rotary switch again and then select  Menu or  Home .



### 7.2.7 ALARMS

Use the rotary switch to select "Alarms" and press to open:



Two options will be displayed:



Icon	Description
	Alarm history
	Wash alarms



#### ALARM HISTORY

This function serves to view the history of control unit alarms:

Error found
Cup warmer probe 1 error
Pressure error
Group dose error 1
Group dose error 2
Group dose error 1

Turn the rotary switch to navigate through the two pages with the list of errors stored in the control unit.

To delete the alarm history, press the wash button  on the control panel and hold it down for 3 seconds.

To quit, press the rotary switch again and then select  Menu or  Home.

### WASH ALARMS

This function serves to set the timer (hours and minutes) for the group wash alarm.

E.g. setting 1 h and 30 min., will cause the machine to send a wash alarm message after 1h and 30 min.

It is possible to access this function pressing the rotary switch. Use the rotary switch to select from the ACTIVE and NON ACTIVE modes.

Selecting NON ACTIVE  using the rotary switch will return to the main menu.



Selecting ACTIVE  it is then necessary to use the rotary switch to set the hours and minutes after which the alarm message appears.



After the minutes have been set, the machine returns to the main menu.





### 7.2.8 TECHNICAL SETTINGS

Use the rotary switch to highlight the "Technical settings" icon and press to open:

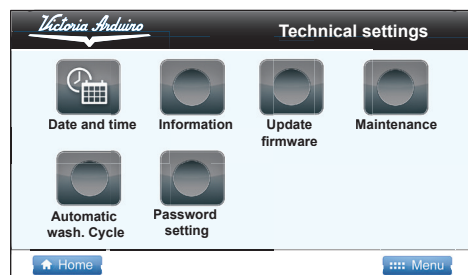

The display will show the 6 options:



Icon	Description
	Date and time.
	Information.
	Firmware update.
	Maintenance.
	Automatic wash cycle.

Icon	Description
	Password setting.

### DATE AND TIME

This function serves to change the date and time setting for the machine and it is viewed from the "Home Page".

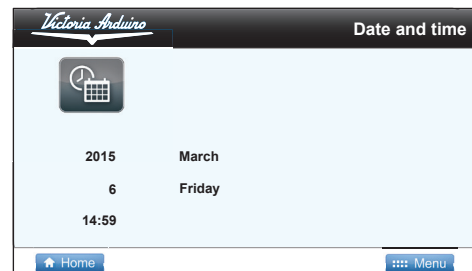

Once the icon has been selected with the rotary switch, press it to access the change mode for the year, month, day, hour and minutes. After the minutes have been set, the machine returns to the main menu.

### INFORMATION

This function serves to view the main information about the machine and the software.

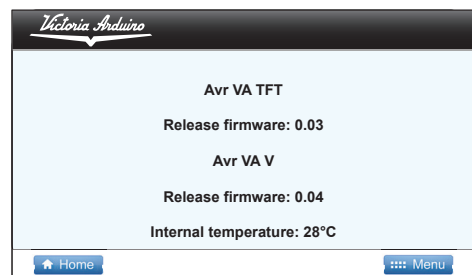

By keeping the washing button  pressed for at least 5 seconds, enter the configuration page of the control unit to set further parameters.

ENGLISH

This possibility is reserved to skilled technician only.

Among the most important parameters there are:

- TARE DELAY
- PREINFUSION

**TARE DELAY (gravimetric only)**

During the tare delay, VA388 continuously tare the cup weight on the grid. At the end of the time set with the tare delay, the machine starts to weigh normally. This parameter varies between 0.5 and 10 seconds with 0.1 seconds interval.

**PREINFUSION**

The digital preinfusion can be set, that is the machine delivers water for a time that can be set (time ON), stops for a period that can be set (time OFF), and then continues the delivery. By selecting the digital preinfusion ON, the following parameters can be changed (gravimetric version):

1. Pour time OFF: In the total pour time count the pour time OFF set can be included (ON) or excluded (OFF);
2. Preinfusion Time ON: It sets the pour starting time, when the coffee pad gets wet. It changes from 0.5 to 3 seconds with 0.1 second interval.
3. Preinfusion Time OFF: It sets the pause time before the pouring continues. It changes from 2 to 8 seconds with 0.1 second interval.



**FIRMWARE UPDATE** 

This screen is used to update the firmware inside the machine.

Follow the procedures described on the display and use the special USB socket in the control panel.

**MAINTENANCE** 

This function serves to set scheduled maintenance.

It is possible to programme the number of deliveries and the date after which the maintenance alarm will be enabled.

The alarm is triggered when the hour counter or date is reached.

The machine will continue to operate as normal. Select the icon with the rotary switch and press it. The number of deliveries will start to flash.

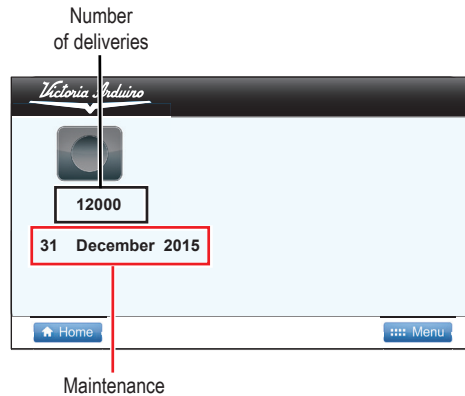

Change the number of deliveries with the rotary switch and press to confirm.

Use the same method to change the day, month and year for the maintenance date.

Once having carried out the modifications, reset the inner counter of the cycles to make them effective.

Keep the washing key pressed  for 5 seconds to reset the inner counter. A message relative to the counter zeroing will be displayed.

**AUTOMATIC WASH CYCLE** 

This function serves to carry out an automatic wash cycle for the groups.

**NOTE:** It is possible to open the wash function by

pressing the wash button .

Insert the blind filter in the filter holder, add half a dose of Pulicaff and insert the filter holder into the group to be cleaned automatically. Use the rotary switch to select the group to be washed and press the switch:

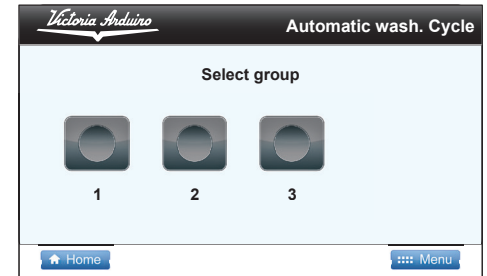

The machine views:

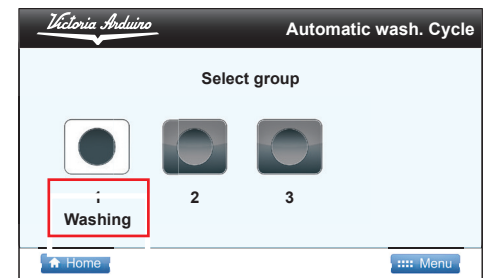

The cycle will start automatically for the group.

It is possible to select one of the other groups. At the end, select  Menu or  Home to exit.

In this case, the screen will display (E.g. Wash group 1 only):



Once the washing has been finished, the rinse stage is requested automatically:

The washing button  will start to flash; press it and the machine will display:

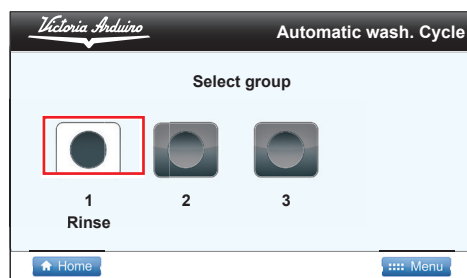

Empty the blind filter of any Pulicaff residues and re-insert the filter holder into the group. Press the rotary switch on the group to be rinsed, then select  the screen will show:



**NOTE:** During the selected group wash cycle, it is possible to deliver coffee from the groups that have not been selected.

## PASSWORD SETTINGS

This page is used to enter the login password, when it is required and enabled. The password may consist of 4 numbers from 0 to 9 in any combination.

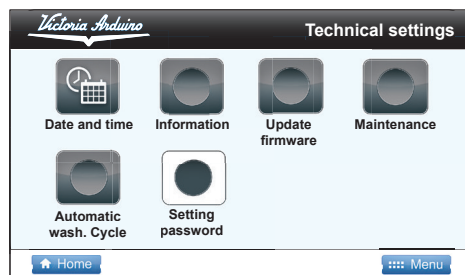

The password length may be included between 0 (password disabled or invalid, characterized by horizontal lines) and 4 digits; therefore, even a password of 2 digits is valid.

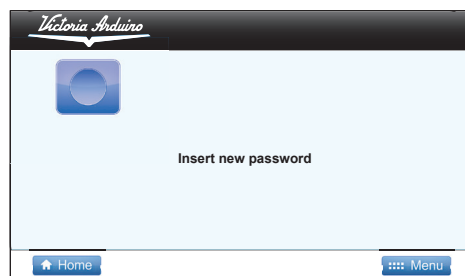

Once having entered and confirmed the password, an information page will show the result of the comparison between the entered password and the one previously set. To enter the pages inside the various menus, when the password is unknown, the pass-partout password may be used. The value of this password is 1 9 0 5.

## Change of password

This page, which is contained in the technical settings menu, permits to change the password. It is necessary to first confirm the password set (for safety reasons), if the password management is enabled.

Once having entered and confirmed the password, an information page will show the result of the comparison between the entered password and the one previously set.

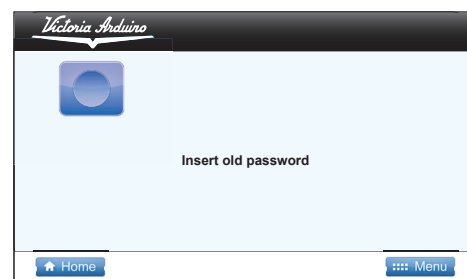

Subsequently, the new password to be set will be requested.

## 8. CLEANING

### 8.1 STOP

Stop the machine with the three main switches, moving them to the position 0.



Fig. 22

### 8.2 CLEANING THE OUTSIDE OF THE MACHINE

The machine must be set to "0" power (switch off and disconnecter open) before any cleaning operations are performed.



**WARNING**

It is not possible to clean the machine using water jets or standing it in water



**WARNING**

Do not use solvents, chlorine-based products or abrasives.

**Cleaning the work area:** remove the worktop, lifting it up from the front and sliding it out. Remove the water collection dish underneath and clean everything with hot water and cleansers.

**Cleaning the bottom:** To clean all the chromium-plated areas, use a soft, damp cloth.

### 8.3 CHANGING THE WATER IN THE BOILER

To always ensure the best quality water, the water in the boiler must be changed daily whilst being used. Repeatedly press the hot water key to remove at least a third of the total litres contained in the boiler.

### 8.4 CLEANING THE STAINLESS COFFEE-HOLDERS

The stainless steel showers are located under the delivery units.

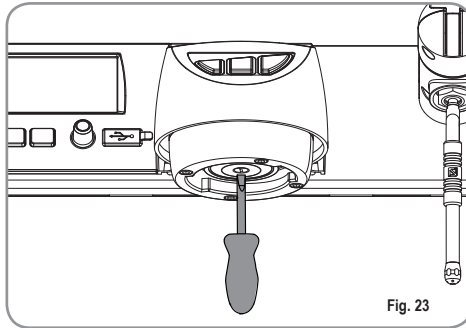

Fig. 23

**NOTE:** To clean proceed as follows:

- Turn the screw placed in the centre of the coffee-holder.
- Slide the coffee-holder out and check that its holes are not obstructed but clean.
- If obstructed, clean as described (Paragraph "CLEANING FILTERS AND FILTER-HOLDERS")  
We recommend cleaning the coffee-holder once a week.

### 8.5 CLEANING THE UNIT WITH THE AID OF THE BLIND FILTER

The machine is set to wash the delivery group with an automatic cleaning cycle and specific powder detergent. It is advisable to wash the machine at least once a day.

### 8.6 CLEANING FILTERS AND FILTER-HOLDERS

Place two teaspoons of special cleanser in half a litre of hot water and immerse filter and filter-holder (without its handle) in it leaving them to soak for at least half an hour. Then rinse abundantly with running water.

## 9. MAINTENANCE

**NOTE:** During maintenance/repairs, the parts used must be able to guarantee compliance with the safety and hygiene requirements envisaged for the device. Original replacement parts can offer this guarantee.

**NOTE:** After the repair or replacement of any components of parts that come into contact with food or water, it is necessary to carry out the washing procedure as described in point 1.4 or according to the manufacturer's instructions.

### 9.1 RESIN AND SOFTENER REGENERATION

To avoid scaling deposits in the boiler and in the heating exchangers, the softener must always be kept efficient.

Therefore, the ionic resins must be regularly regenerated.

Regeneration times are established according to the quantity of coffee delivered daily and the hardness of the water utilised

These can be seen in the diagram included in the following figure.

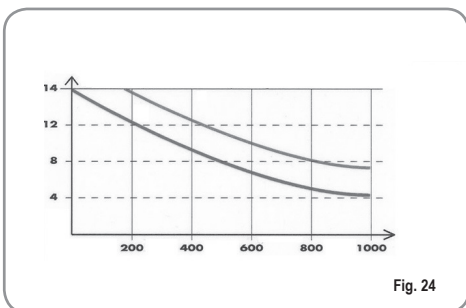

Fig. 24

Regeneration procedures are as follows:

1) Turn the machine off and place a container large enough to contain at least 5 litres under tube E.

Turn levers C and D from left to right; take the cap off by unscrewing knob and fill with 1 Kg normal kitchen salt.

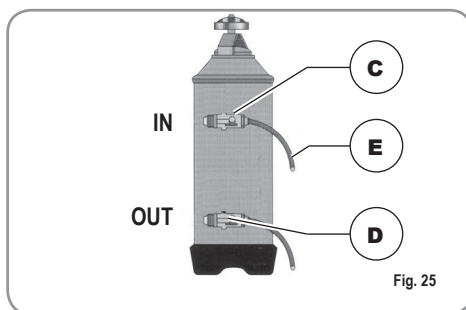

Fig. 25

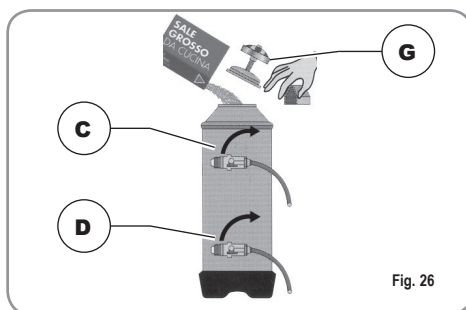

Fig. 26

2) Put the cap back on and reposition lever C moving it towards the left and allowing tube F to discharge the salty water until it has been eliminated and the water becomes fresh again (about half an hour).

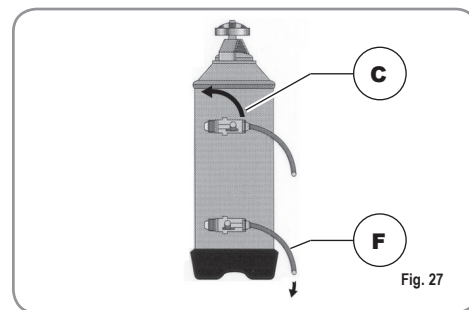

Fig. 27

3) Reposition lever D towards the left.

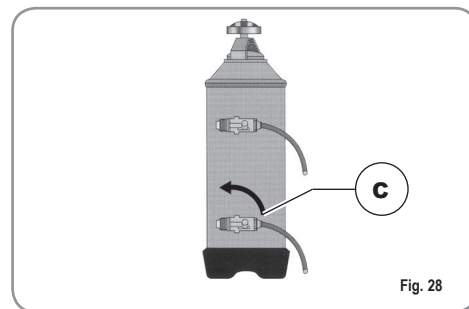
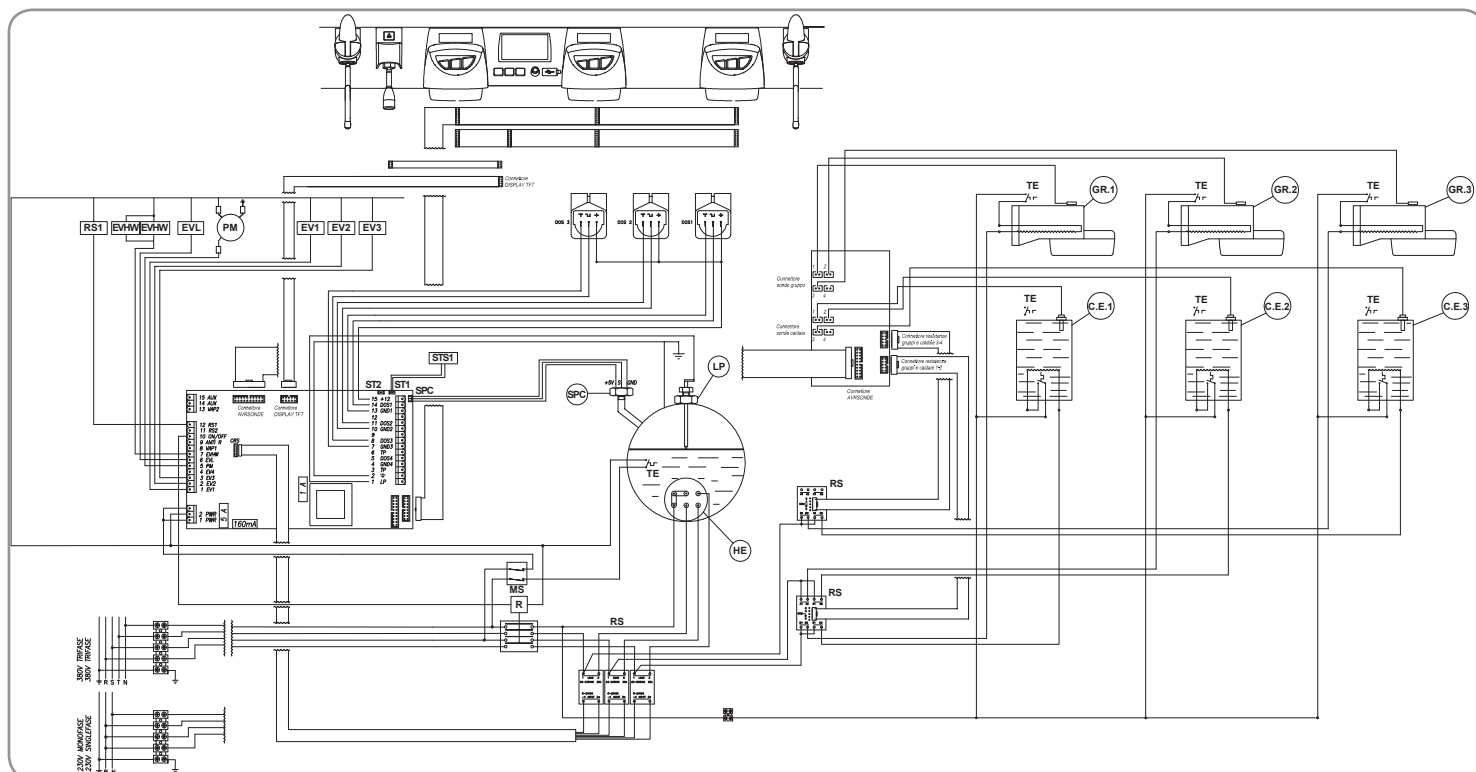

Fig. 28

# IMPIANTO ELETTRICO / ELECTRIC SYSTEM / INSTALLATION ÉLECTRIQUE VA388



## LEGENDA / KEY / LÉGENDE

**MS** Interruttore / Switch / Interrupteur.  
**R** Relè / Relay / Relais.  
**RS** Relè statico / Relay / Relais.  
**PM** Motore pompa / Pump Motor / Moteur pompe.  
**HE** Resistenza boiler / Boiler heater element / Résistance chaudière.  
**LP** Sonda livello / Level probe / Sonde niveau.  
**EV1** Elettrovalvola gruppo 1 / Electrovalve group 1 / Electrovanne groupe 1.  
**EV2** Elettrovalvola gruppo 2 / Electrovalve group 2 / Electrovanne groupe 2.  
**TE** Termostato / Thermostat / Thermostat.  
**EV3** Elettrovalvola gruppo 3 / Electrovalve group 3 / Electrovanne groupe 3.  
**EVHW** Elettrovalvola miscelatore / Mixer electrovalve / Electrovanne mélangeur.

**EVL** Elettrovalvola livello / Water level elec. / Electrovanne niveau.  
**STS1** Sonda temperatura scaldatazze 1 / Cupwarmer temperature probe 1 / Sonde température chauffe-tasses 1.  
**STS2** Sonda temperatura scaldatazze 2 / Cupwarmer temperature probe 2 / Sonde température chauffe-tasses 2.  
**SPC** Sensore pressione caldaia / Sensor pressure boiler / Capteur pression chaudière.  
**RS1** Resistenza scaldatazze 1 / Cupwarmer heating element 1 / Résistance chauffe-tasses 1.  
**RS2** Resistenza scaldatazze 2 / Cupwarmer heating element 2 / Résistance chauffe-tasses 2.

**CRS** Connettore relè statici / Connector static relays / Connecteur relais statiques.  
**EVS** Elettrovalvola sfiato / Vacuum electrovalve / Electrovanne vide.

# IMPIANTO ELETTRICO / ELECTRIC SYSTEM / INSTALLATION ÉLECTRIQUE VA388 (CSA version)

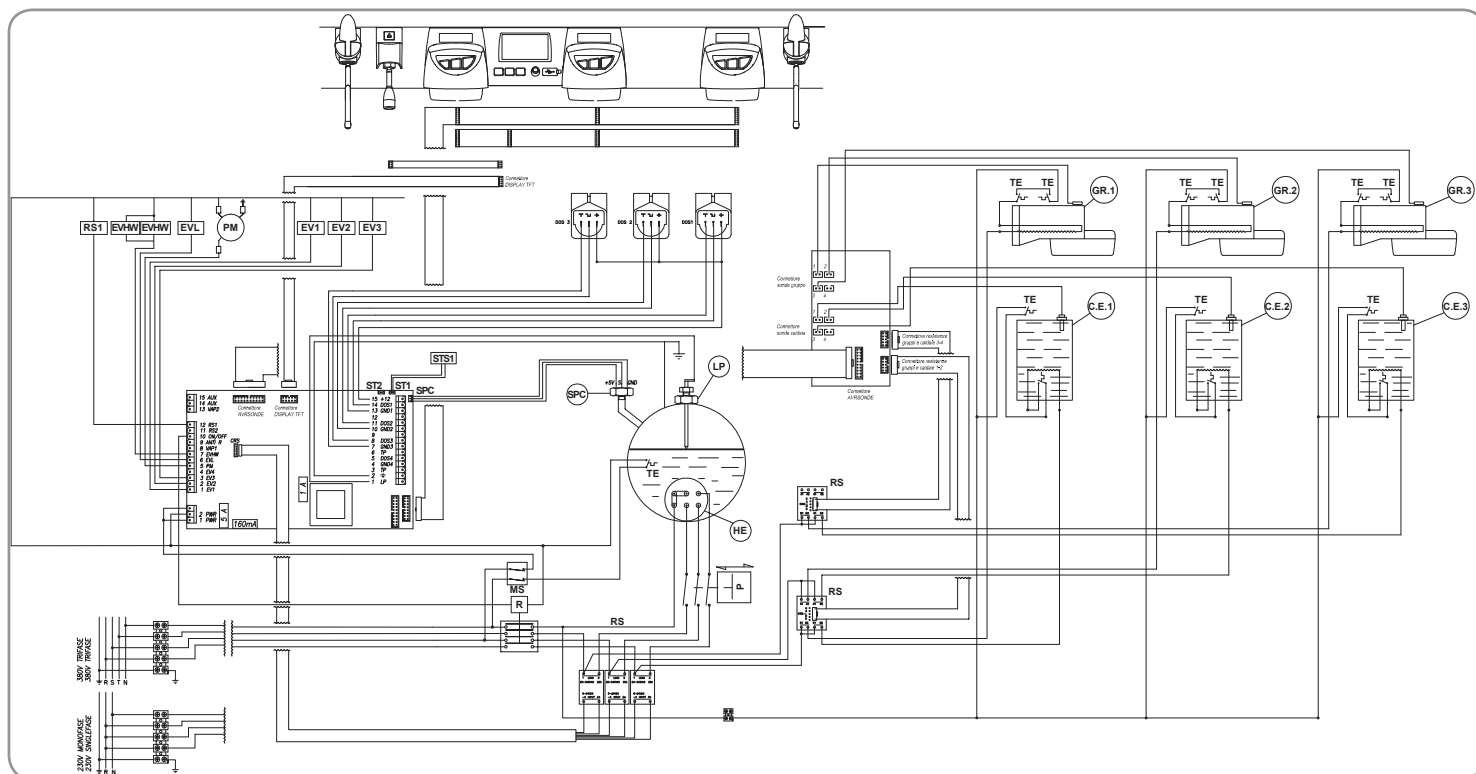

## LEGENDA / KEY / LÉGENDE

**MS** Interruttore / Switch / Interrupteur.  
**R** Relè / Relay / Relais.  
**RS** Relè statico / Relay / Relais.  
**PM** Motore pompa / Pump Motor / Moteur pompe.  
**HE** Resistenza boiler / Boiler heater element / Résistance chaudière.  
**LP** Sonda livello / Level probe / Sonde niveau.  
**EV1** Elettrovalvola gruppo 1 / Electrovalve group 1 / Electrovanne groupe 1.  
**EV2** Elettrovalvola gruppo 2 / Electrovalve group 2 / Electrovanne groupe 2.  
**TE** Termostato / Thermostat / Thermostat.  
**EV3** Elettrovalvola gruppo 3 / Electrovalve group 3 / Electrovanne groupe 3.  
**EVHW** Elettrovalvola miscelatore / Mixer electrovalve / Electrovanne mélangeur.

**EVL** Elettrovalvola livello / Water level elec. / Electrovanne niveau.  
**STS1** Sonda temperatura scaldatazze 1 / Cupwarmer temperature probe 1 / Sonde température chauffe-tasses 1.  
**STS2** Sonda temperatura scaldatazze 2 / Cupwarmer temperature probe 2 / Sonde température chauffe-tasses 2.  
**SPC** Sensore pressione caldaia / Sensor pressure boiler / Capteur pression chaudière.  
**RS1** Resistenza scaldatazze 1 / Cupwarmer heating element 1 / Résistance chauffe-tasses 1.  
**RS2** Resistenza scaldatazze 2 / Cupwarmer heating element 2 / Résistance chauffe-tasses 2

**CRS** Connettore relè statici / Connector static relays / Connecteur relais statiques.  
**EVS** Elettrovalvola sfiato / Vacuum electrovalve / Electrovanne vide.



# SCHEMA CALDAIA / BOILER DIAGRAM / SCHÉMA DE CHAUDIÈRE VA388 (3 Gr.)

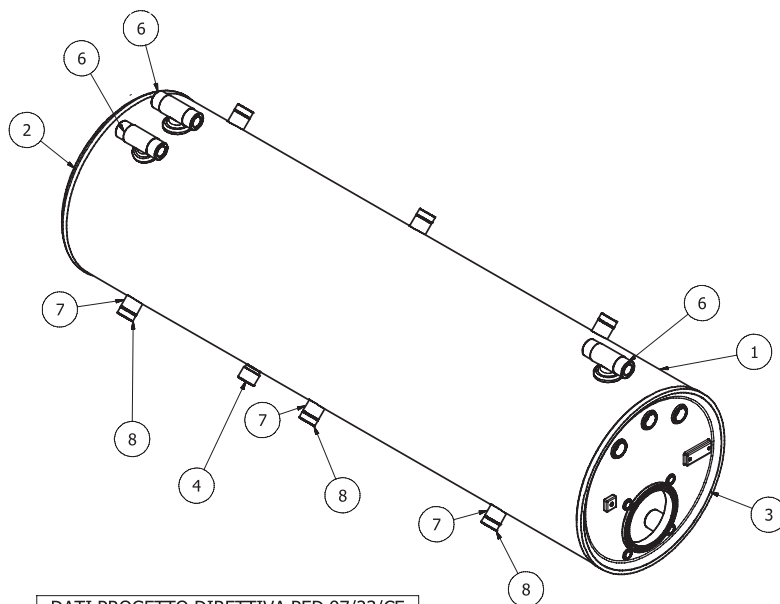
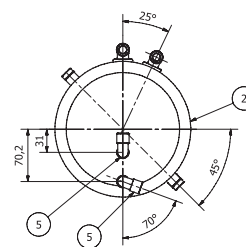
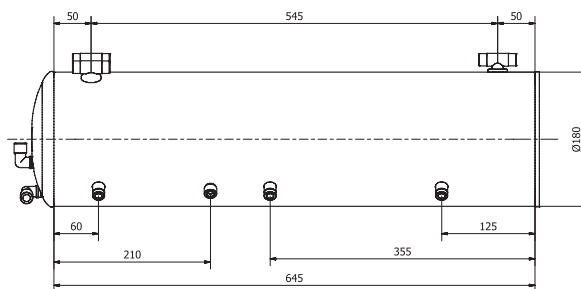
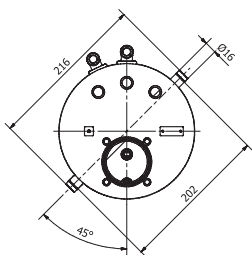

Elenco parti List of Parts Liste des composants					
ELEMENTO ELEMENT ELEMENT	QTÀ QTY QTE	NUMERO PARTE PART NO. NUMERO COMPONENT	DESCRIZIONE DESCRIPTION DESCRIPTION	MATERIALE MATERIAL MATERIAU	NORME STANDARD NORMES
1	1	00014340	Corpo caldaia VA388 0.180 3 Gr Boiler body VA388 0.180 3 Gr Corps chaudière VA388 0.180 3 Gr	Rame Cu-DHP 99.9 Copper CIJ-DHP 99.9 Cuivre CIJ-DHP 99.9	EN10204-3.1 B
2	1	00010370	Coppa D.180 2 fori Bevel gear D.180 2 holes Coupe D.180 2 trous	Rame Cu-DHP 99.9 Copper CIJ-DHP 99.9 Cuivre CIJ-DHP 99.9	EN10204
3	1	00060280	FLANGIA CALDAIA d 180 BOILER FLANGE d 180 FLASQUE CHAUDIERE d 180	OT57 CW510L	
4	1	00030251	Attacco 3/8" Maschio OT57 CW510L Coupling 3/8" Male OT57 CW51DL Prise 3/8" Mâle OT57 CW51DL	OT57 CW510L	EN12164
5	2	00061551	Gomito a saldare 3/8 M OT57 CW510L Elbow for welding 3/8 M OT57 CW51DL Coude à souder 3/8 M OT57 CW51DL	OT57 CW510L	
6	3	00061871	Attacco presa vapore OT 57 CW510L Steam inlet coupling OT 57 CW51DL Prise vapeur OT 57 CW51DL	OT57 CW510L	
7	3	00161510	Tubo scab D16X1 Pipe D16X1 Tube échangeur D16X1	Rame Cu-DHP 99.9 Copper CIJ-DHP 99.9 Cuivre CIJ-DHP 99.9	EN 12735-1
8	6	00030531	Attacco G1-8 F passante OT57 CW510L Coupling G1-8 F through OT57 CW510L Prise G1-8 F passante OT57 CW510L	OT57 CW510L	EN12164
materiali Material Matériau		trattamento Treatment Traitement		scala Scale Echelle	
Rame,ottone Copper, brass Cuivre, laiton		Decapaggio Pickling Décapage		A2	
descrizione Description Description		data Date Date			
Caldaia Boiler Chaudière		D.180 3Gr VA388 OT57		05/08/2011	
descrizione Description Description		progettista Designer Concepteur		codice Code Code	
NS 98030503		MF		90014740	

DATI PROGETTO DIRETTIVA PED 97/23/CE PROJECT DATA FOR DIRECTIVE PED 97/13/EC DONNEES PROJET DIRECTIVE PED 97/13/CE	
VOLUME VOLUME VOLUME	17 LT
TS	130.5°
MPa max.	0.18
PT	2.7 Bar
FLUIDO FLUID FLUIDE	H2O

# SCHEMA CALDAIA / BOILER DIAGRAM / SCHÉMA DE CHAUDIÈRE VA388 (2 Gr.)

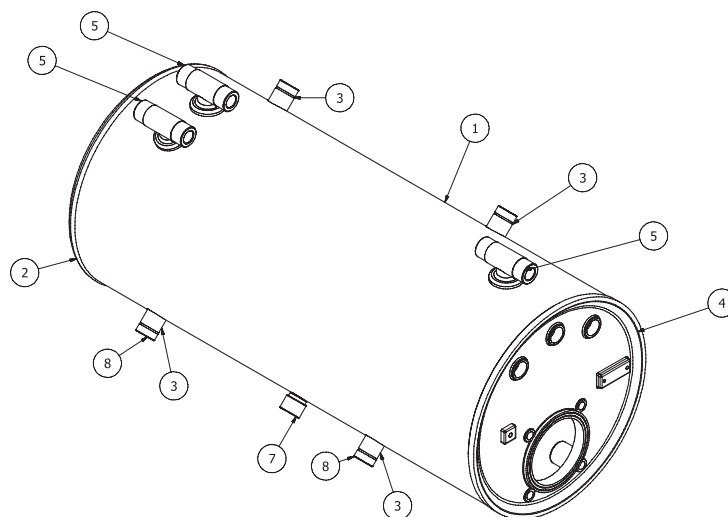
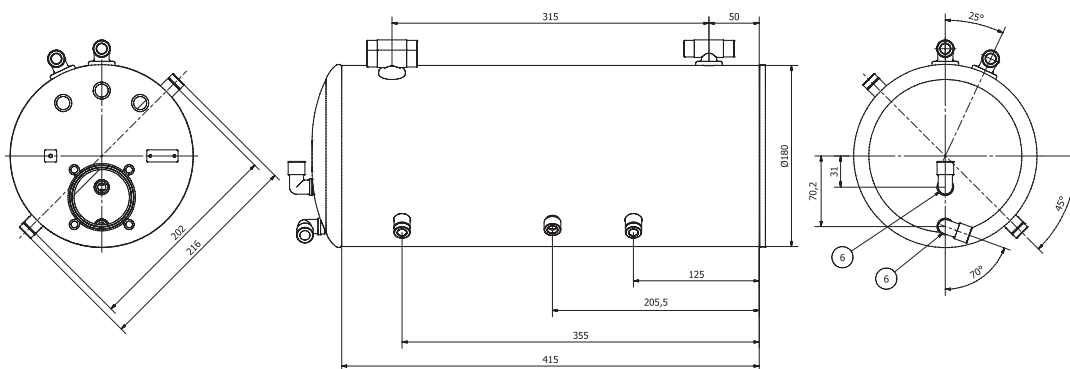

Elenco parti / List of Parts / Liste des composants					
ELEMENTO ELEMENT ELEMENT	QTÀ QTY QTE	NUMERO PARTE PART NO. NUM. COMPOSANT	DESCRIZIONE DESCRIPTION DESCRIPTION	MATERIALE MATERIAL MATERIAU	NORME STANDARD NORMES
1	1	00014330	Corpo caldaia VA388 D.180 2 Gr Boiler body VA388 D.180 2 Gr Corps chaudière VA388 D.180 2 Gr	Rame Cu-DHP 99.9 Copper CIJ-DHP 99.9 Cuivre CIJ-DHP 99.9	EN10204-3.1 B
2	1	00010370	Coppa D.180 2 fori Bevel gear D.180 2 holes Coupe D.180 2 trous	Rame Cu-DHP 99.9 Copper CIJ-DHP 99.9 Cuivre CIJ-DHP 99.9	EN10204
3	2	00161510	Tubo scab D16X1 Pipe D16X1 Tube échangeur D16X1	Rame Cu-DHP 99.9 Copper CIJ-DHP 99.9 Cuivre CIJ-DHP 99.9	EN12735-1
4	1	00060280	FLANGIA CALDAIA d 180 BOILER FLANGE d 180 FLASQUE CHAUDIERE d 180	OT57 Cw510L	
5	3	00061871	Attacco presa vapore OT 57 CW510L Steam inlet coupling OT 57 CW51DL Prise vapeur OT 57 CW51DL	OT57 CW510L	
6	2	00061551	Gomito a saldare 3/8 M OT57 CW510L Elbow for welding 3/8 M OT57 CW51DL Coude à souder 3/8 M OT57 CW51DL	OT57 CW510L	
7	1	00030251	Attacco 3/8" Maschio OT57 CW510L Coupling 3/8" Male OT57 CW51DL Prise 3/8" Mâle OT57 CW51DL	OT57 CW510L	EN12164
8	4	00030531	Attacco G1-8 F passante OT57 CW510L Coupling G1-8 F through OT57 CW510L Prise G1-8 F passante OT57 CW510L	OT57CW510L	EN12164
materiale / Material / Matériau		trattamento / Treatment / Traitement		toleranza / Tolerance / Tolérance	scala / Scale / Echelle
Rame, ottone Copper, brass Cuivre, laiton		Decapaggio Pickling Décapage		Media Average Moyenne	A2
descrizione / Description / Description		Caldaia / Boiler / Chaudière D.180 2Gr VA388 OT57			data / Date / Date
NS 98030502					05/08/2011
		progettista / Designer / Concepteur		codice / Code / Code	
		MF		90014730	

DATI PROGETTO DIRETTIVA PED 97/23/CE  
PROJECT DATA FOR DIRECTIVE PED 97/13/EC  
DONNEES PROJET DIRECTIVE PED 97/13/CE

VOLUME VOLUME VOLUME	11.3 LT
TS	130.5°
MPa max.	0.18
PT	2.7 Bar
FLUIDO FLUID FLUIDE	H2O

# SCHEMA CALDAIA / BOILER DIAGRAM / SCHÉMA DE CHAUDIÈRE VA388 (2 - 3 Gr.)

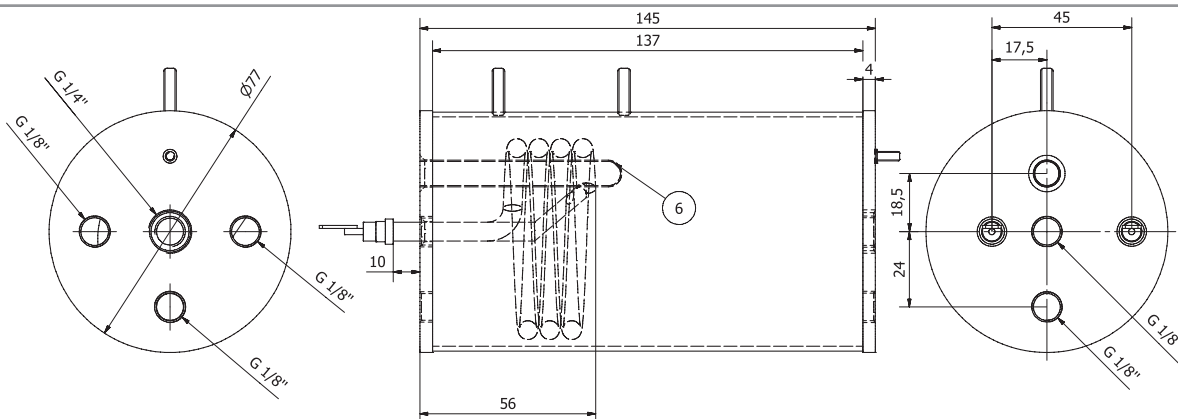

Elenco parti List of Parts Liste des composants				
ELEMENTO ELEMENT ELEMENT	QTÀ QTY QTE	NUMERO PARTE PART NO. NUM. COMPOSANT	DESCRIZIONE DESCRIPTION DESCRIPTION	MATERIALE MATERIAL MATERIAU
1	1	00041000	Flangia Pr Lavorata Inox +1 Microbar Flange Pr machined, stainless steel +1 Microbar Flasque Pr finition inox +1 Microbar	STAINLESS STEEL AISI316L
2	1	00040500	Flangia 4 fori Lavorata Inox Microbar Flange 4 holes machined, stainless steel Microbar Flasque 4 trous finition inox Microbar	STAINLESS STEEL AISI316L
3	1	00160770	Tubo inox D.76.1 sp1.5 Aisi 316L Stainless steel pipe D.76.1 sp1.5 Aisi 316L Tube inox D.76.1 ép.1.5 Aisi 316L	STAINLESS STEEL AISI316L
4	1	00110900	Resistenza a saldare 1000W 230V inox versione 2009 (Disegno GGS63597) Heating element for welding 1000W 230V Stainless steel version 2009 (Dwg. GGS63597) Résistance à souder 1000W 230V Inox version 2009 (Dessin GGS63597)	INCOLOY800
5	1	00080800	Prigioniero M3x8 inox Stud M3x8 stainless steel Boulon prisonnier M3x8 inox	STAINLESS STEEL
6	1		Tubetto porta bulbo Microbar Inox Bulb support tube microbar stainless steel Tube porte-bulbe Microbar Inox	STAINLESS STEEL
7	2	00081210	Prigioniero M4x15 Inox Stud M4x15 stainless steel Boulon prisonnier M4x15 Inox	STAINLESS STEEL
materiale Material Matériau Acciaio inox aisi 316L Stainless steel Aisi 316L Acier inox Aisi 316L		trattamento Treatment Traitement	toleranza Tolerance Tolérance	scala Scale Echelle
			media Average Moyenne	A3
descrizione Description Description Caldaia Boiler Chaudière D.76.1 Microbar inox 230V				data Date Date 10/01/08
descrizione Description Description 98030308 Nuova Simonelli			progettista Designer Concepteur Marco Feliziani	codice Code Code 90040280

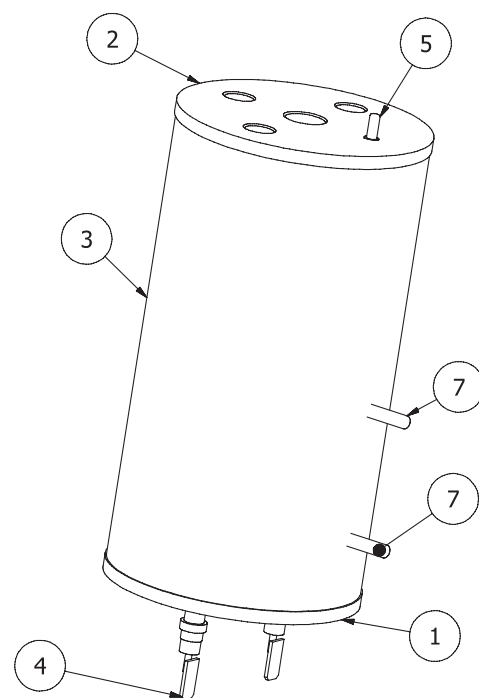

Nota: Boiler in zona di applicazione articolo 3, comme 3 97/23/CE  
 Note: Boiler in application area, article 3, section 3 97/23/CE  
 Note: Chauffe-eau dans zone d'application article 3, alinéa 3 97/23/CE

